

ArcGIS® 9

Geodatabase Workbook



Copyright © 2004 ESRI
All rights reserved.
Printed in the United States of America.

The information contained in this document is the exclusive property of ESRI. This work is protected under United States copyright law and other international copyright treaties and conventions. No part of this work may be reproduced or transmitted in any form or by any means, electronic or mechanical, including photocopying and recording, or by any information storage or retrieval system, except as expressly permitted in writing by ESRI. All requests should be sent to Attention: Contracts Manager, ESRI, 380 New York Street, Redlands, CA 92373-8100, USA.

The information contained in this document is subject to change without notice.

DATA CREDITS

Graphical Editing Map: Wilson, North Carolina

Universal Data Editor Map, Editing in data view and layout view map: Greeley, Colorado

Context menus and shortcut keys map: PFRA, Regina, Saskatchewan, Canada

Editing Tutorial Data: Wilson, North Carolina; Greeley, Colorado; PFRA, Regina, Saskatchewan, Canada

Map Topology Tutorial Data: U.S. Geological Survey in cooperation with U.S. Environmental Protection Agency, National Hydrography Dataset

Map Topology Tutorial Data: U.S. Geological Survey National Elevation Dataset Shaded Relief Image Service, published on the Geography Network

Topological Data Loading Tutorial Data: U.S. Geological Survey in cooperation with U.S. Environmental Protection Agency and Utah AGRC and REDCON

Creating and Editing Annotation Tutorial Data: U.S. Geological Survey National Elevation Dataset Shaded Relief Image Service, published on the Geography Network

Creating and Editing Annotation Tutorial Data: U.S. Geological Survey in cooperation with U.S. Environmental Protection Agency, National Hydrography Dataset

Creating and Editing Annotation Tutorial Data: National Atlas of the United States and the United States Geological Survey, Geographic Data Technology, Inc. (GDT), ESRI

CONTRIBUTING WRITERS

Bob Booth, Jeff Shaner, Andy MacDonald, Phil Sanchez, Rhonda Pfaff

U.S. GOVERNMENT RESTRICTED/LIMITED RIGHTS

Any software, documentation, and/or data delivered hereunder is subject to the terms of the License Agreement. In no event shall the U.S. Government acquire greater than RESTRICTED/LIMITED RIGHTS. At a minimum, use, duplication, or disclosure by the U.S. Government is subject to restrictions as set forth in FAR §52.227-14 Alternates I, II, and III (JUN 1987); FAR §52.227-19 (JUN 1987) and/or FAR §12.211/12.212 (Commercial Technical Data/Computer Software); and DFARS §252.227-7015 (NOV 1995) (Technical Data) and/or DFARS §227.7202 (Computer Software), as applicable. Contractor/Manufacturer is ESRI, 380 New York Street, Redlands, CA 92373-8100, USA.

ESRI, ArcView, the ESRI globe logo, ArcGIS, ArcMap, ArcCatalog, ArcEditor, ArcInfo, the ArcGIS logo, Geography Network, ArcSDE, SDE, Spatial Database Engine, GIS by ESRI, and www.esri.com are trademarks, registered trademarks, or service marks of ESRI in the United States, the European Community, or certain other jurisdictions.

Other companies and products mentioned herein are trademarks or registered trademarks of their respective trademark owners.

Quick-start tutorial

2

IN THIS CHAPTER

- Exploring data in ArcCatalog
- Editing attributes of geodatabase features
- Finding and correcting topology errors
- Making topological edits
- Editing geometric network features

In this quick-start exercise, you will use ArcMap to edit a geodatabase that models a part of a city. The geodatabase contains two feature datasets that model a water utility network and a planning department's land parcel records.

This geodatabase contains *subtypes*, *validation rules*, *relationships*, a *geometric network*, and a *topology*. You will use ArcMap to take advantage of the behavior built into this geodatabase. You can get more information about italicized terms in the glossary or consult the relevant chapters in *Building a Geodatabase* and *Editing in ArcMap*.

This chapter assumes that you have some familiarity with ArcGIS and that you are using an ArcEditor or ArcInfo licensed seat of ArcMap. The tutorial is intended to familiarize you with the basics of editing feature classes that have advanced geodatabase behavior.

Exploring data in ArcCatalog

Before you begin the tutorial, you must find the data and maps that you will need. You will use ArcCatalog to browse your data in this exercise.

Connecting to data

ArcCatalog lets you organize your local GIS data and maps in folders and easily access them through folder connections. You can access multiuser geodatabases by making database connections. When you look in a folder connection, you can quickly see the folders and data sources it contains. You will begin by creating a folder connection to the quick-start tutorial data.

1. Start ArcCatalog by either double-clicking a shortcut installed on your desktop or using the Programs list in your Start menu.
2. Click the Connect To Folder button.

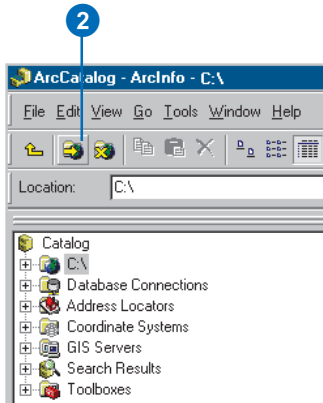

3. Navigate to the EditingWithArcGIS folder on the local drive where you installed the tutorial data. The default installation path is
C:\arcgis\ArcTutor\EditingWithArcGIS.

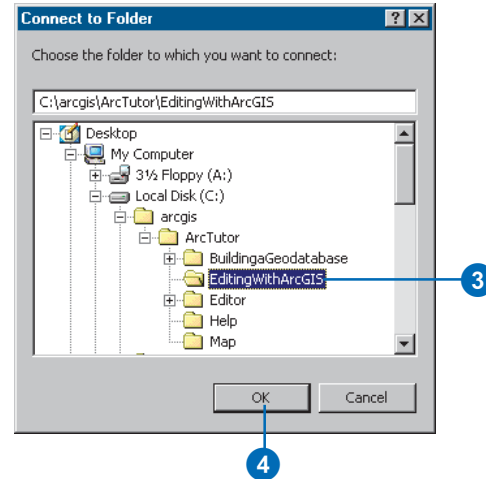

4. Click OK.

Your new folder connection—

C:\arcgis\ArcTutor\EditingWithArcGIS—is now listed in the Catalog tree. You will now be able to access all of the data needed for the quick-start tutorial through this connection.

Exploring your data

Before you begin editing the city geodatabase, you will explore the Landbase and Water feature datasets.

1. Click the plus sign next to the C:\arcgis\ArcTutor\EditingWithArcGIS folder.

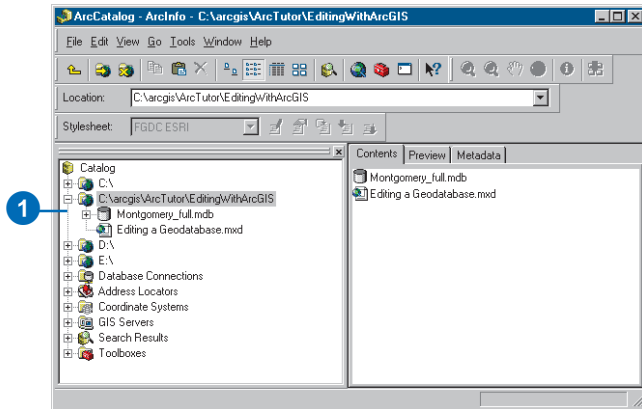

2. Double-click the Montgomery_full geodatabase and double-click the Landbase feature dataset to see the feature classes, relationship classes, and topology it contains.

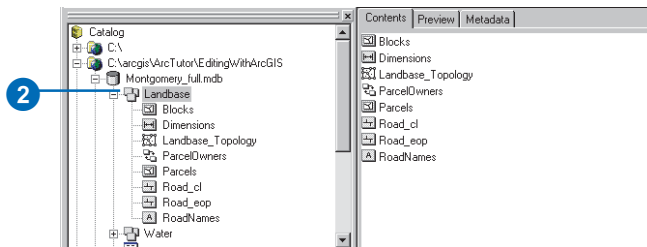

3. Click Parcels feature class.

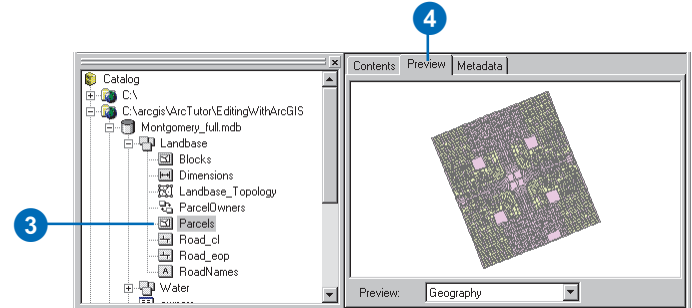

4. Click the Preview tab to preview the Parcels feature class geometry.

This feature class contains two types of parcel features, residential parcels and nonresidential parcels. They are rendered with different colors in the ArcCatalog Preview tab because they have been defined as separate subtypes in the geodatabase.

Subtypes are used to differentiate groups of features within a feature class that may share many of the same characteristics, yet have important differences in the typical values of some of their attributes or the role they play in the geodatabase. For example, a road feature class could have highway, arterial street, and residential street subtypes. All are types of streets, but highways might typically have four or more lanes and speed limits in the 45–70 mph range, while residential streets might always have two lanes and speed limits in the 15–30 mph range. The subtypes could have default values and range domains that reflect these differences.

Two subtypes within a feature class can have different topology and connectivity rules associated with them and often have different default values for certain attributes. Subtypes, default values, and attribute domains can help you ensure that your geodatabase contains high-quality attribute data. For more information about subtypes, see the ‘Subtypes’ chapter in *Building a Geodatabase*.

In this geodatabase, residential parcels have a default value of Residential for their zoning code, while nonresidential parcels have a default value of Commercial. Nonresidential parcels may be given another zoning code value, but since many of the nonresidential parcels are commercial, the default was set to Commercial as a convenience for the geodatabase editors.

5. Click the Owners table in the geodatabase.

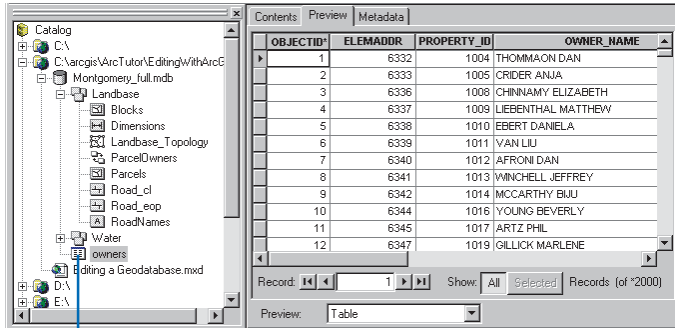

5

Notice how the Preview type automatically changes to Table and displays the table’s records. This table contains the owner information for the Parcels feature class.

ParcelOwners is another type of geodatabase object, a relationship class. Relationship classes store information about how spatial objects, such as feature classes, or nonspatial objects, such as tables, are related to other objects within a geodatabase. ParcelOwners links the Owners table to the Parcels feature class. When you edit the parcels in ArcMap, you can view and edit the related data in the Owners table. For more information about relationship classes, see the ‘Relationship classes’ chapter in *Building a Geodatabase*.

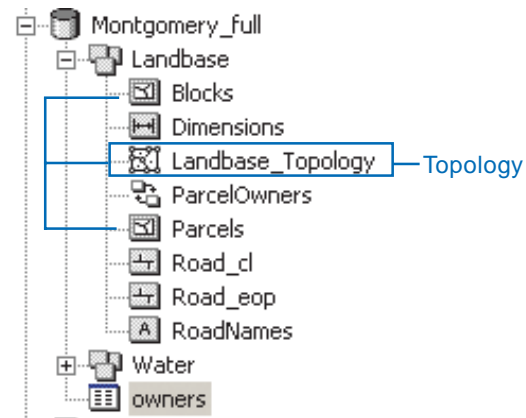

Landbase_Topology is a topology in the dataset. It provides rules that structure how the polygon features in the Parcels feature class can be spatially related to each other and how one subtype of Parcels can be related to one subtype of Blocks. Topologies help you maintain high-quality spatial data in your geodatabase. For more information about topologies, see the ‘Topology’ chapter in *Building a Geodatabase*.

6. Double-click Water.

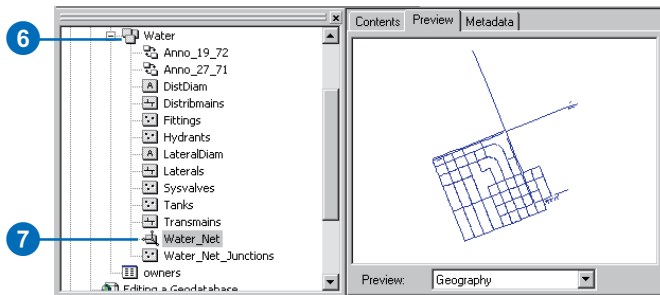

This dataset also contains relationship classes, annotation, and feature classes.

7. Click Water_Net.

Water_Net is a geometric network, another type of topological relationship, between the feature classes in this dataset. Geometric networks allow you to model networks of edges and junctions, such as the pipes and valves in a water system or the wires and switches in an electrical power grid. They let you conduct connectivity traces and flow analyses on the features in the network and provide some special editing functionality that is useful for networks. For more information about geometric networks, see the 'Geometric networks' chapter in *Building a Geodatabase*.

A relationship class, Anno_19_72, links a set of annotation to the Laterals features. If a water lateral is edited, the corresponding piece of annotation will be updated.

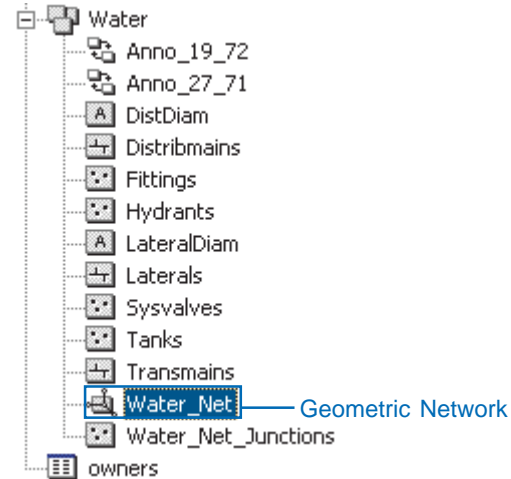

8. Click Editing a Geodatabase.mxd.

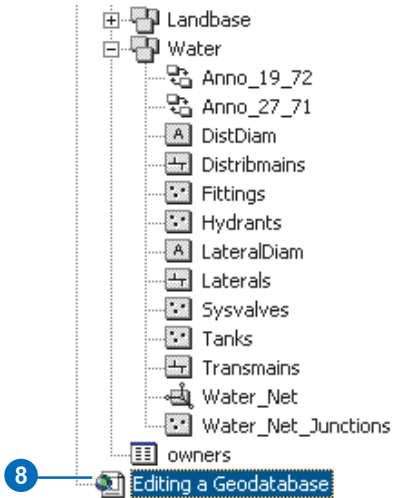

This is a map that you will use to edit the geodatabase objects you've been exploring. For more information about maps, see *Using ArcMap*.

In this section, you've explored the contents of the EditingWithArcGIS folder. In the next section, you will begin to do some advanced attribute editing on this geodatabase.

Editing attributes of geodatabase features

Imagine you work for the city planning department, and you have been asked to update the attributes of some parcels. You will edit attributes of geodatabase feature classes, edit values in a table connected to a feature class by a relationship class, and change the subtype of a feature.

Opening a map and starting to edit

1. Start ArcMap by double-clicking Editing a Geodatabase.mxd.



ArcMap starts, and you see a section of the city. You are going to edit some features on this map, so you'll need to add the Editor toolbar and the Topology toolbar to the map.

2. Click View, point to Toolbars, and click Editor.
3. Click View, point to Toolbars, and click Topology to add the Topology toolbar.

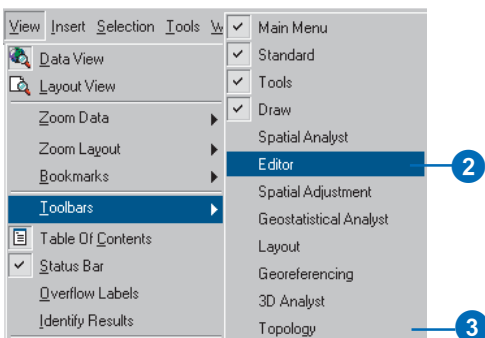

The Editor and Topology toolbars appear.

4. On the Editor toolbar, click Editor and click Start Editing.



Visiting a bookmarked area

Now you'll zoom to an area that has been defined by a spatial bookmark in the map and select some features to edit.

1. Click View, point to Bookmarks, and click EditParcel.

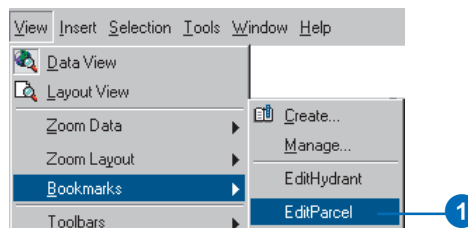

- Click the Select Features tool.



- Select a group of light green office parcels by dragging a box around them.

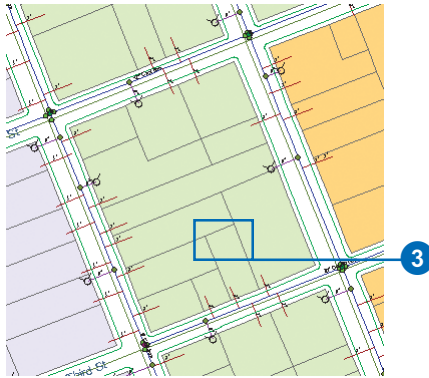

Viewing and editing values in a related table

Now you'll edit the Owners table, which is related to the Parcels feature class by the Parcel Owners relationship class.

- Click the Attributes button on the Editor toolbar.



The Attributes dialog box now appears with a list of the selected parcels' PROPERTY_ID values. The attribute values of the first selected parcel are displayed on the right panel.

Each parcel has a plus sign next to it. You can navigate to the related row in the Owners table from each parcel.

- Double-click the feature ID of parcel 4381 (it may not be the first in the list).

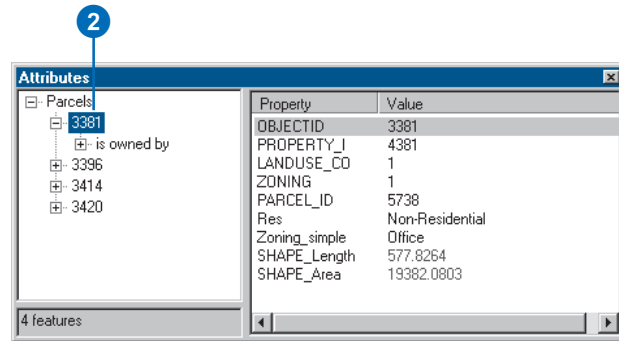

The database designer decided that a logical label for related fields in the Owners table, when viewed from the Parcels attributes, is 'is owned by'. You can specify such labels when you create a relationship class.

- Click the plus sign next to 'is owned by'.

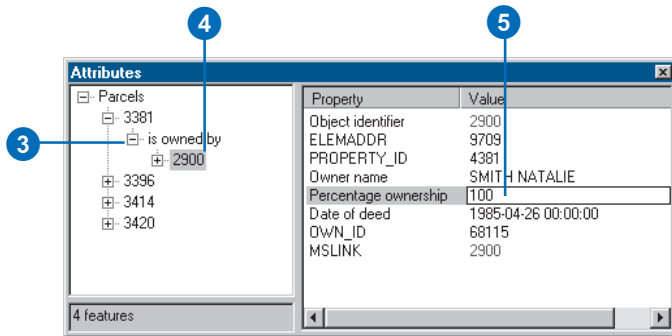

The identification number of the record in the Owners table that is related to—owns—this parcel is displayed under the 'is owned by' label.

- Click the Owner Object identifier, 2900.

You are now viewing a record in the Owners table in the geodatabase. The attributes of the owner of this parcel are listed on the right panel. Some of the field names that are shown in this window are aliases instead of the true field names. Aliases are created by the geodatabase designer to make the usually short and sometimes cryptic database field names easier to read and understand. In this case, for example, one of the geodatabase fields is called OWNER_PERCENT. The alias 'Percentage ownership' was created to provide a more understandable label for the field in the Attributes window.

You can edit the values for this owner's attributes easily using the Attributes window.

- Click the value for Percentage ownership and type "100".

- Press Enter.

You have used the ParcelOwners relationship class to find the owner for a selected parcel feature and to edit that owner record in the related geodatabase table. Relationship classes can also be used to link two features or tables to each other or to link annotation to features. The geodatabase lets you use the relationship class to easily navigate between related objects and to maintain the referential integrity of the database.

Editing the subtype and an attribute of a feature

Now you'll edit the parcels feature class. You will change the subtype of a parcel and also edit an attribute of a parcel.

- Click the PROPERTY_ID of parcel 4381 in the Attributes window selection list.

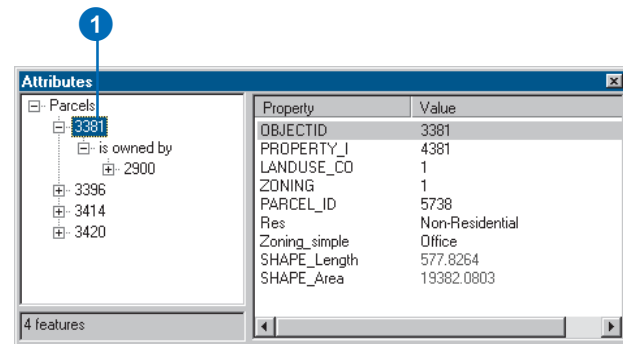

When you first viewed the parcel feature class in ArcCatalog, the features were drawn in two different colors because there are two subtypes of parcel. On this

map the parcels are rendered using their Zoning_simple attribute rather than their subtype. Each parcel subtype has different default values defined for its Zoning_simple field. You will change the subtype of a parcel and see how other fields are updated with a new default value.

2. Click Non-Residential in the Value column to the right of the Res attribute.

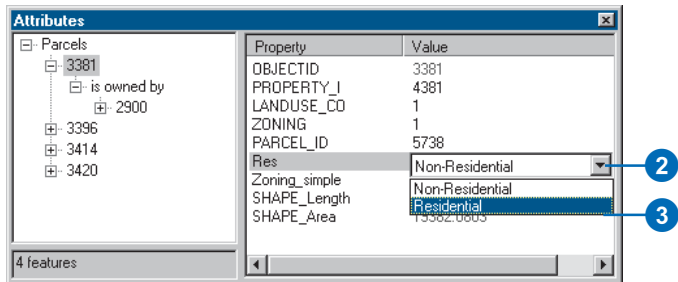

The Attributes window gives you a dropdown list that will let you select one of the two possible values for this field.

3. Click Residential in the list of two values.

This field is associated with a coded value *attribute domain* in the geodatabase. Coded value domains allow you to edit more quickly and accurately because you can pick from the list of predefined permissible values. There's no need to type the data into the field, and there's no possibility of entering a typo.

The attribute stored in this field is also the code that identifies which subtype the feature belongs to. Notice that when you changed the parcel's subtype attribute to Residential, the subtype of the parcel immediately changed. The value of the Zoning_simple attribute also

changed, as you can see in the Attributes window and on the map. This is because Residential is the default value for this attribute of parcels of the Residential subtype.

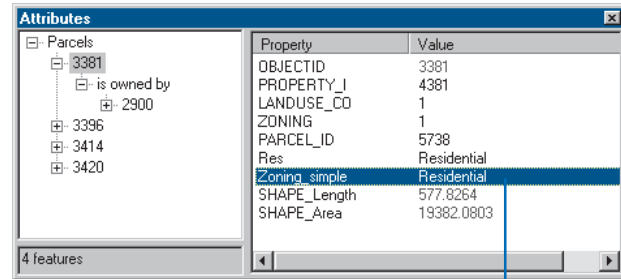

New attribute value from default value of Residential subtype



Next, you'll edit another parcel's subtype and attributes.

4. Click the PROPERTY_ID of parcel 4396 in the Attributes window.

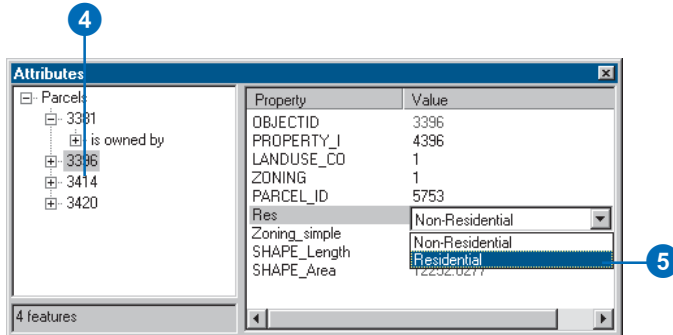

5. Click Non-Residential in the Value column to the right of the Res attribute and click Residential.

Notice that the Zoning_simple field is again updated with the default value, Residential.

6. Click in the Value column for the Res attribute and click Non-Residential to change the parcel's subtype back to Non-Residential.

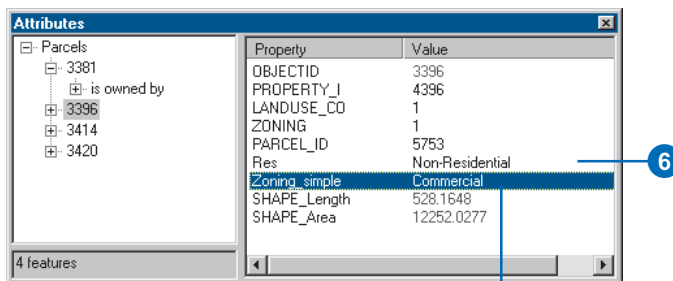

New value for Zoning_simple field

Notice that the Zoning_simple field is updated again, but now it has a new value—Commercial. The feature's symbol on the map is also a new color.

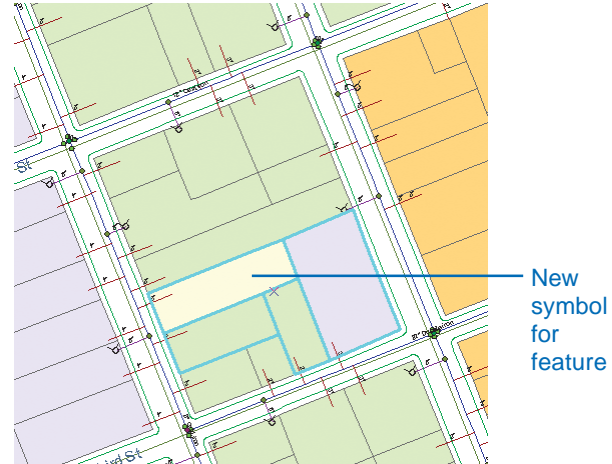

When the geodatabase was designed, it was decided that most new parcel features of the Non-Residential subtype would probably be commercial property, so Commercial was made the default value for nonresidential parcels.

Just because a parcel is nonresidential does not mean that it must have the Zoning_simple code Commercial. This parcel has been reclassified by the planning department as Manufacturing. You will update the Zoning_simple code to its new value.

- Click Commercial in the Zoning_simple Value column and click Manufacturing.

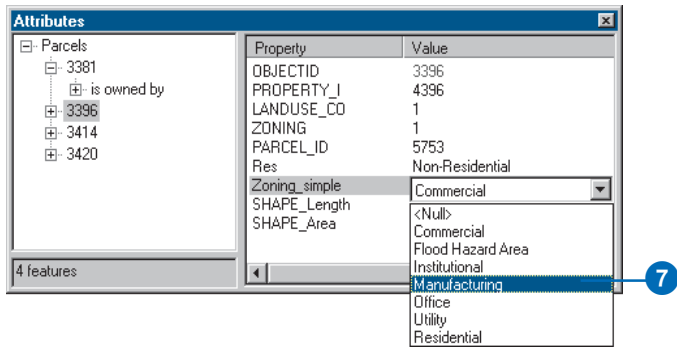

- Close the Attributes dialog box.

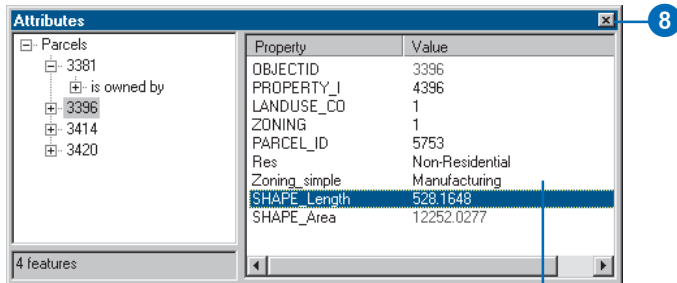

Updated value for attribute

You have updated the parcel's zoning code in the geodatabase and have seen how default values and coded value domains can make editing feature attributes quick and easy.

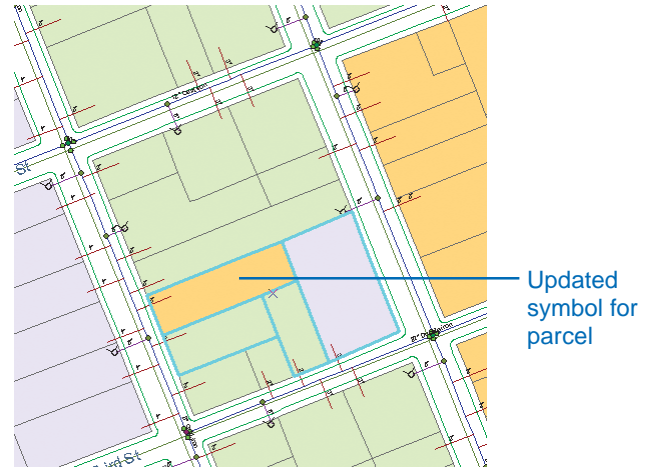

In the next section you will examine the results of your edits on the feature dataset's topology, Landbase_Topology.

Finding and correcting topology errors

Now you will check the edits you've just made to find out if they violate the topology rules defined for these features.

A geodatabase topology defines a structured set of permissible spatial relationships between features within a subtype or feature class or between features in two subtypes or feature classes. These relationships are specified by topology rules when the topology is created. There are many possible topological relationships that could be important for a geodatabase, so ArcGIS allows you a great deal of flexibility in defining topological relationships. The Topology toolbar provides tools to help you find and correct topology errors and also provides editing tools to help you avoid creating topology errors when editing features in a topology.

Validating topology edits

Although you haven't changed the geometry of any features, you have changed the subtype of a couple of features. If a subtype of a feature class is specified in a topology rule, changing the subtype can create topology errors.

1. On the Topology toolbar, click the Validate Topology In Current Extent button.



The topology is validated within the area that is currently visible on your map.

Validating a topology can sometimes take some time to complete, especially if you have made a large number of edits, you are working on large or complex datasets, or you have many topology rules. Validating the current extent saves time when you are trying to locate errors in a specific area.

The topology validation process identified an error within the area you've just been editing and marked it with a red error feature. Red is the default color for error features, although you can change the way they are symbolized.

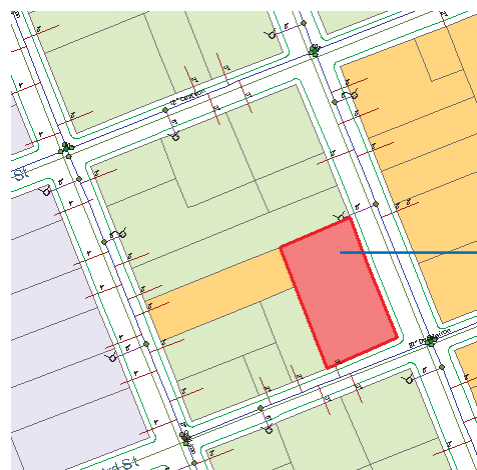

Topology error detected by the validate process

Examining topology properties

Now you'll investigate the properties of this topology to identify what the problem is. The Topology layer lets you view topology errors, as well as other information about the topology, in ArcMap.

1. In the ArcMap table of contents, right-click the Landbase_Topology layer and click Properties.

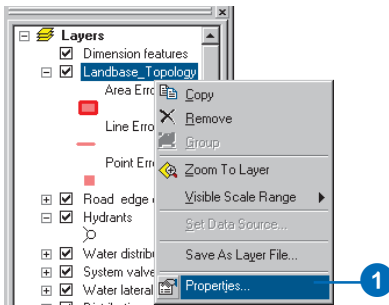

The Layer Properties dialog box for the topology layer opens.

2. Click the Feature Classes tab to see what feature classes in the dataset participate in the topology.

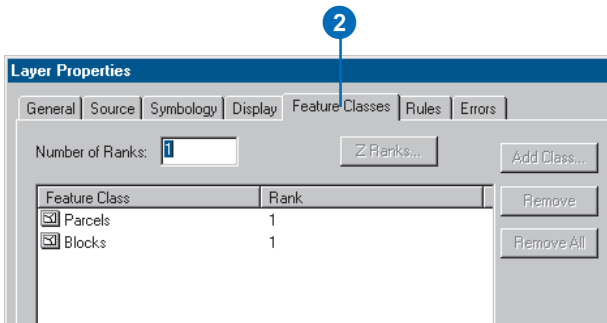

The Parcels feature class that you've just edited is one of two feature classes that participates in the topology, Blocks is the other.

3. Click the Rules tab to see which topology rules may have been violated by your edits.

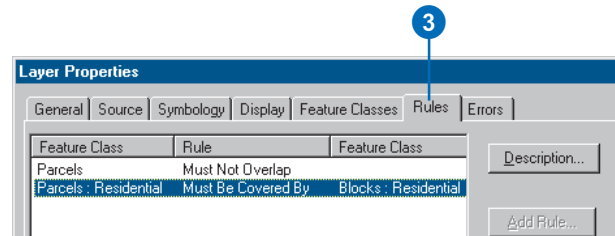

The rules of the topology are listed here. A topology could be created with no rules or with as many as a dozen, or more, depending on the complexity of your data model. The first rule in the list means that features within the feature class Parcels are bound by the Must Not Overlap rule. Parcels that overlap—for example, because of digitizing errors—will be discovered when the topology is validated. This rule does not involve a second feature class, so the second feature class column is empty.

Since you didn't edit any geometry, you're unlikely to have violated the Parcels Must Not Overlap rule. However, the second rule, Parcels: Residential Must Be Covered By Blocks: Residential involves the Residential subtype of the Parcels feature class, which you did edit. It states that Residential subtype features in Parcels must be covered by Residential subtype features in Blocks.

- Click the row for the rule Parcels: Residential Must be Covered By Blocks: Residential.

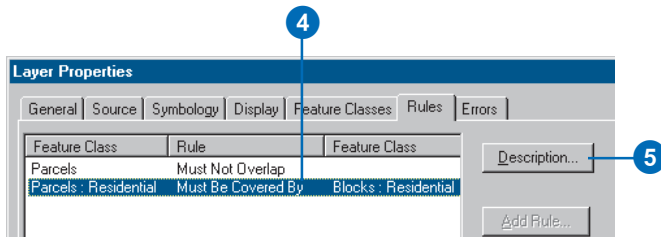

- Click Description.

A dialog box appears with a brief description of the topology rule.

- Uncheck Show Errors.

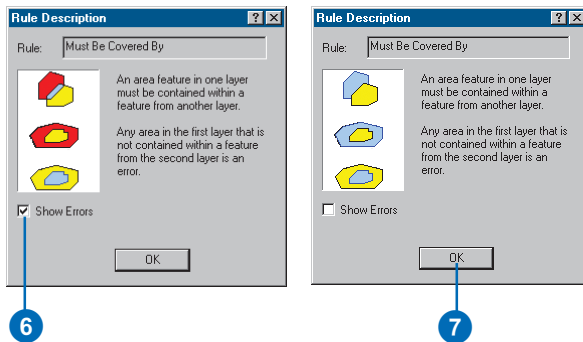

You can check and uncheck the Show Errors box to compare cartoon examples of features and the topology errors that they would produce. The red parts of the graphic represent error features.

- Click OK.

- Close the Layer Properties dialog box for the topology layers.

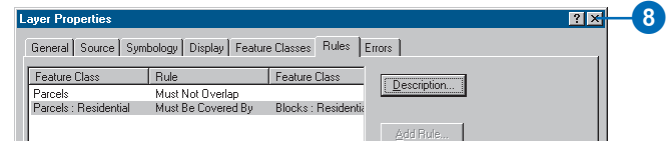

Next you'll use another method to explore topology errors.

Inspecting topology errors

Now you'll examine the errors in the topology using the Error Inspector.

- Click the Error Inspector button on the Topology toolbar.



The Error Inspector window appears. You can allow it to float on the map, or you can dock it to the ArcMap application frame.

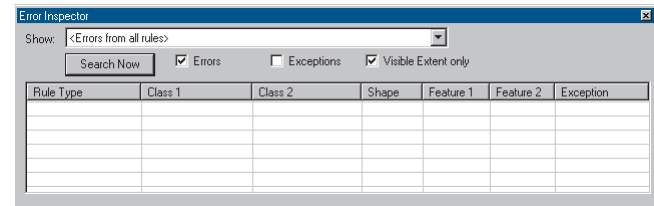

The Error Inspector will selectively show the errors where this rule is violated.

- Click the Show dropdown list to choose what types of errors to display and click Parcels: Residential - Must Be Covered By - Blocks: Residential.

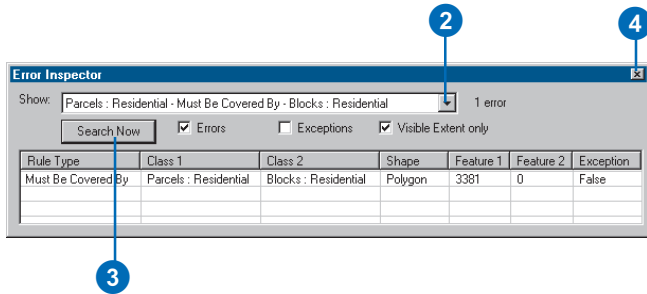

- Click Search Now.

The Error Inspector shows the error that is visible in the current extent.

You can also use the Error Inspector to find all errors, regardless of their type or whether they are in the visible extent, or you can use it to find exceptions to topology rules. An exception is an error feature that has been marked as representing a valid exception to a topology rule.

- Close the Error Inspector dialog box.

Fixing topology errors

In this feature dataset the Blocks feature class represents city blocks. These features have been created simply for demonstration purposes for this tutorial. Blocks have a subtype field that codes them as either Residential or Non-Residential. The Residential block features could be used by the Planning and Zoning office to track whether a given block has parcels that are used for housing. This information could then be used for business permitting purposes or for consideration in the zoning variance review process.

The topology rule Must Be Covered By ensures that residential parcels must be covered by, or fall within, Block features that are marked as residential. You will turn on the Block layer and look at the situation.

- In the table of contents, check the Blocks layer.

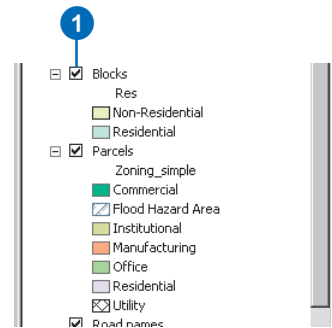

The Blocks layer is partly transparent, so you can see the parcel features through the blocks. The block that contains the error feature is a Non-Residential block. The first Parcel feature that you edited was originally nonresidential. When you edited it, you switched it to the Residential subtype, which triggered this topology error.

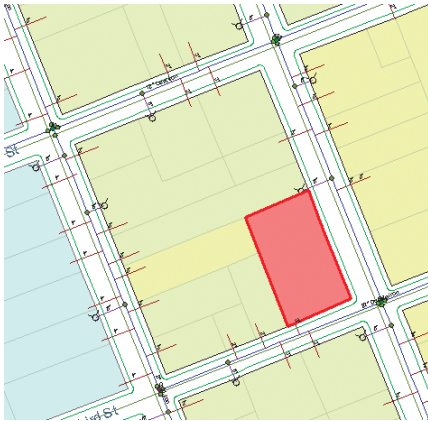

There are several possible ways to deal with this topology error. These include:

- Delete the residential parcel feature.
- Create a new block feature that covers just the residential parcel.
- Mark the error as an exception.
- Ignore the error.
- Change the subtype of the Block feature to Residential.
- Change the subtype of the Parcel feature to Non-Residential.

The correct choice would depend on the planning department's strategy for maintaining the Block and Parcel feature classes. Deleting the parcel is, in this case, not an option. Creating a new special Block feature would not be in accordance with the department's system of monitoring blocks with housing, nor would marking the error as an exception or simply ignoring it. The two most viable options are changing the subtype of the block to Residential or returning the subtype of the parcel to Non-Residential.

Let's assume that the original edit was correct and that this parcel really was supposed to be reassigned to the Residential subtype. It follows that the block should be changed to reflect its new status as a block containing a residential parcel.

2. Click the Select Features tool.



3. Click the block feature at the error feature.

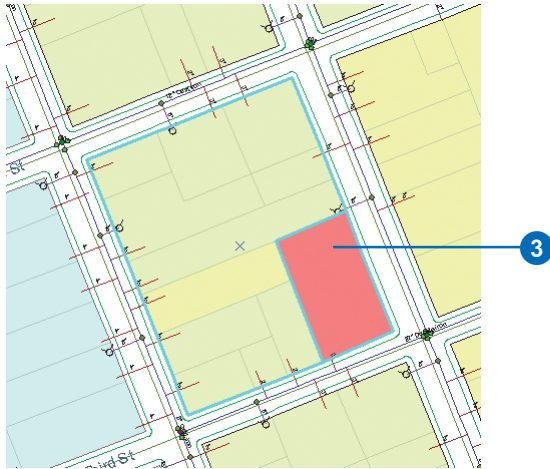

The block is selected.

4. Click the Attributes button on the Editor toolbar.



The Attributes window appears.

5. Click in the Value column beside Residential and click Residential in the dropdown list.

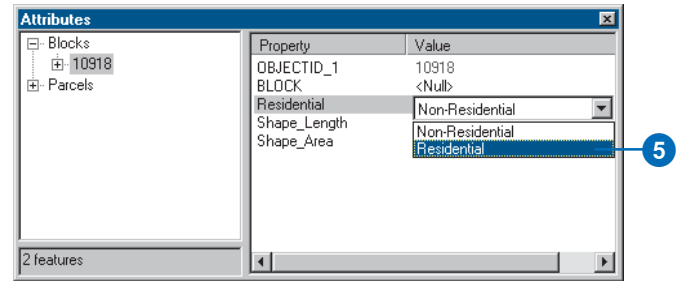

The block changes subtype to Residential, and the symbol for the block is updated on the map.

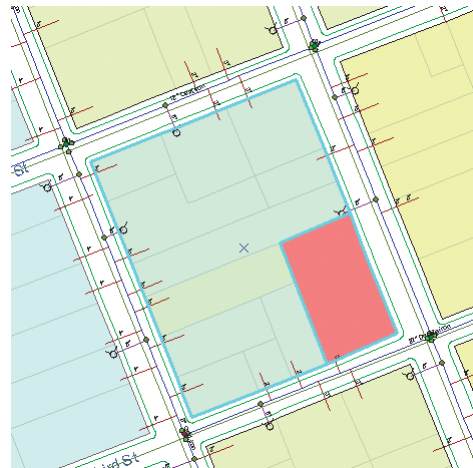

- Click the Validate Topology In Current Extent button and close the Attributes dialog box.



The part of the topology visible on the map is validated, and since there is no longer a violation of the topology rule, the error is removed.

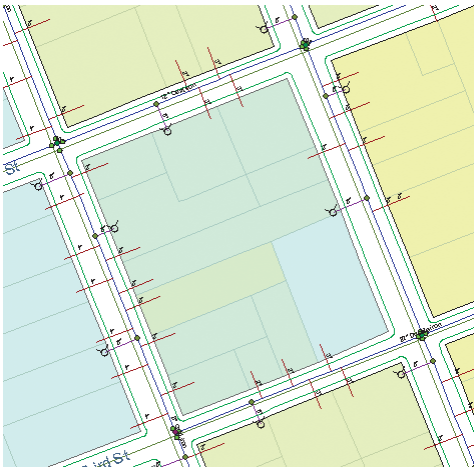

In this exercise you used the topology to maintain a specific spatial relationship between subtypes of the Parcel and Blocks feature classes. In the next exercise you will use the Topology Edit tool to edit a boundary shared by two features.

Making topological edits

Imagine you've been asked to move a parcel boundary to update the planning department's database. You will use the Topology Edit tool to edit the two features that share this boundary. The Topology Edit tool works on parts of features, called edges and nodes. Edges are line segments that define part of a line or part of a polygon boundary. Nodes are the endpoints of topology edges, but they can also be introduced along an edge to provide a convenient point to snap to. Edges and nodes may be shared by several features in multiple feature classes. In this exercise you will move an edge that represents the boundary shared by the two parcel features. You will create two temporary topology nodes to make it easier to move the edge to the new location.

Preparing to edit the parcels

First, you'll need to turn off the Blocks layer, so you don't inadvertently edit the Block feature, then zoom in to the area where you'll be editing.

1. Uncheck Blocks.

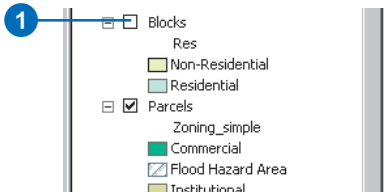

2. Click the Zoom In tool.



3. Click and drag a box around the southern half of the block of parcels that's centered in the display on the map.

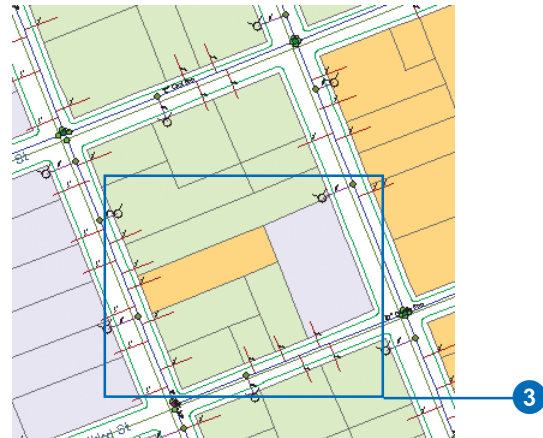

4. Right-click Parcels and click Label Features.

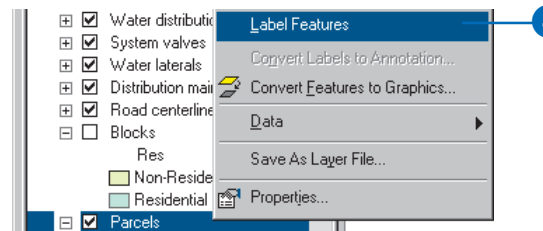



The northern boundary of parcel 4414 needs to be moved 30 feet south of its current position. You will create temporary topology nodes along the parcel's east and west boundaries and snap the north boundary to the new location.

5. Click Editor and click Snapping to set up the snapping environment.

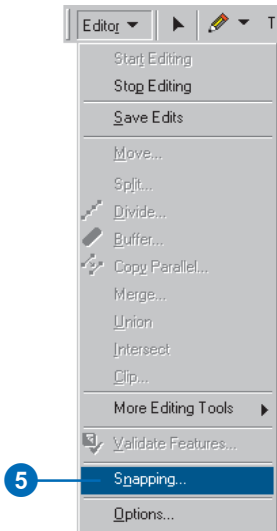

You can snap to different parts of features, the edit sketch, or to topology nodes. You'll set the snapping environment to snap to topology nodes.

6. Check Topology nodes.

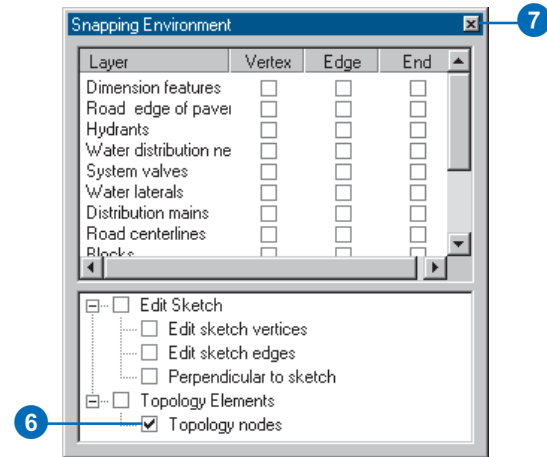

7. Close the Snapping Environment dialog box.

Now you'll change the way the topology nodes are drawn to make editing the parcel boundary easier.

8. Click Editor and click Options.

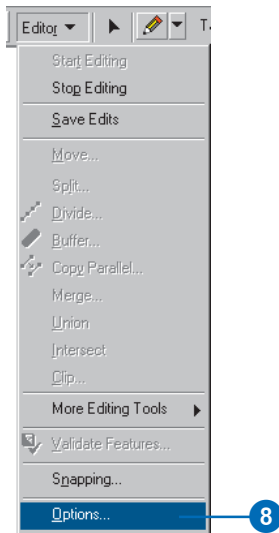

9. Click the Topology tab.

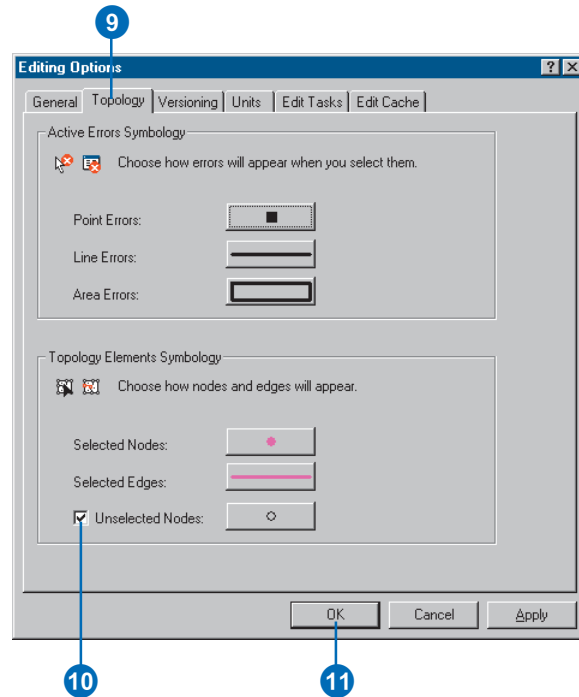

10. Check Unselected Nodes.

Normally, ArcMap shows the selected topology edges and nodes but not the unselected nodes. Since you will be snapping the edge to unselected nodes, it will be useful to be able to see them.

11. Click OK.

Editing the parcels

Now you'll use the Topology Edit tool to split the east and west boundaries to create topology nodes. You'll also check which parcels share the north boundary, then you'll be ready to move it.

1. Click the Topology Edit tool.

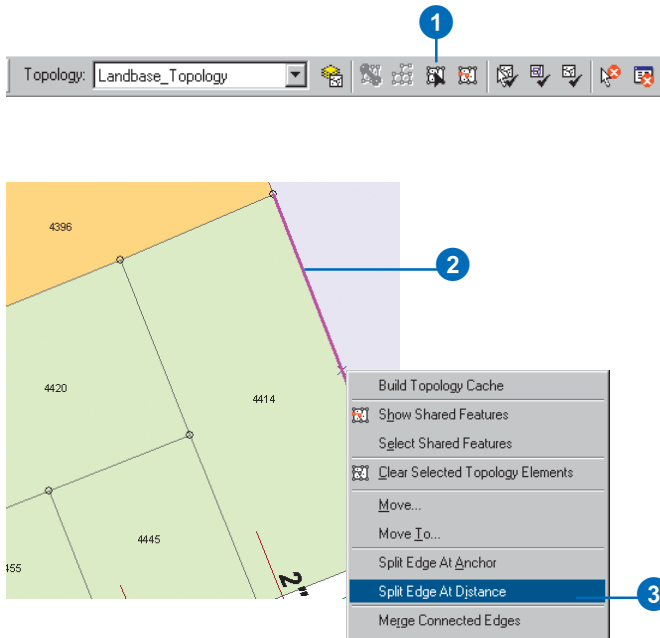

2. Click the eastern boundary of parcel 4414.
The boundary edge is selected and changes color.
3. Right-click the selected edge and click Split Edge at Distance.

The edge now has arrows to show what direction it points. When you split an edge, you need to know which end is the beginning of the edge. The arrows point from the beginning to the end of the edge.

The topological relationships between the features in the current map extent are discovered by the Topology Edit tool when you start editing with the tool and when you rebuild the topology cache. Since these relationships are discovered on the fly and are not stored, the direction of an edge may vary between edit sessions, depending on the current map extent.

4. Look at the arrows on the edge. If they point south, type "30" in the Split text box and press Enter. If they point north, type "30" in the Split text box, click From end point of edge, and press Enter.

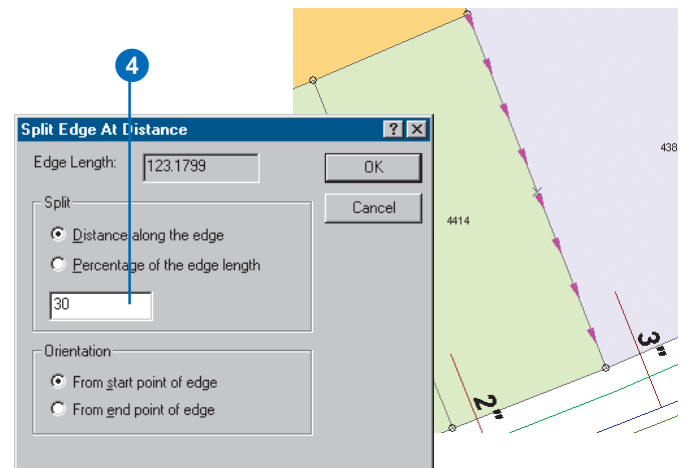

A new topology node is inserted at 30 feet from the north end of the edge.



5. Click the west edge of parcel 4414.

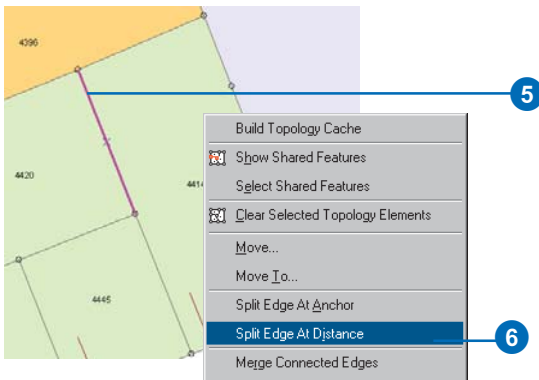

6. Right-click the west edge and click Split Edge At Distance.

7. Look at the arrows on the edge. If they point south, type “30” in the Split text box and press Enter. If they point north, type “30” in the Split text box, click From end point of edge, and press Enter.

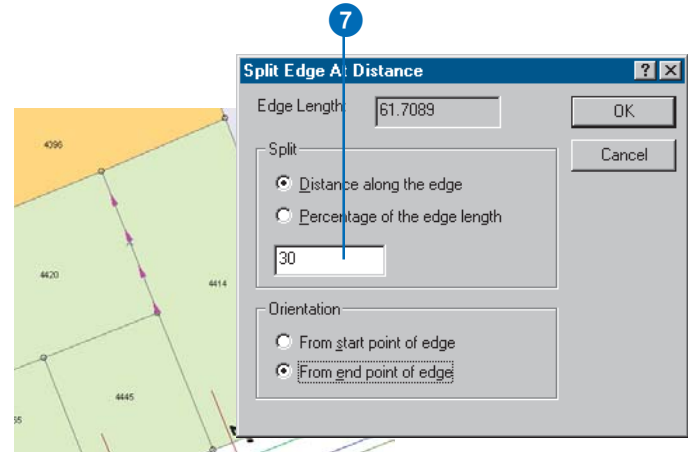

A second new topology node is inserted at 30 feet from the north end of the edge.

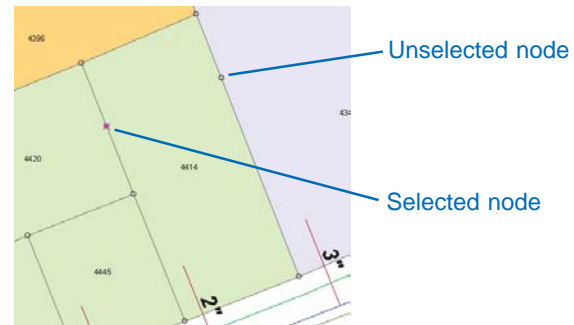

The new topology nodes you added will allow you to snap the northern, shared edge of the parcel to its new location.

Now that both edges have had topology nodes added, you will be able to snap the boundary to the topology nodes. Before you move the edge, you'll check to see which features share it.

- Click the boundary between parcel 4396 and parcel 4414.

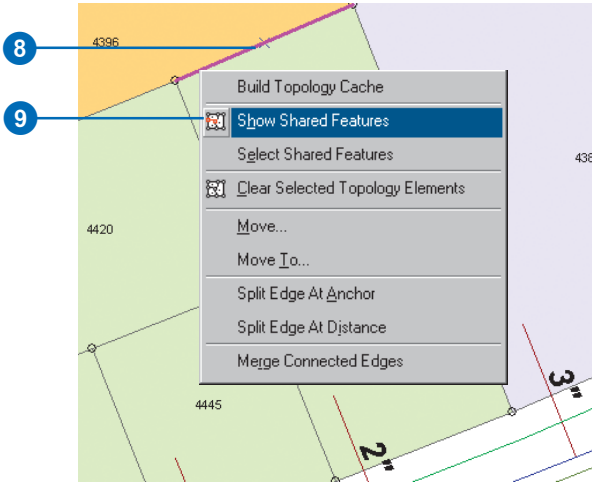

- Right-click and click Show Shared Features.
- Click the plus sign beside Parcels.

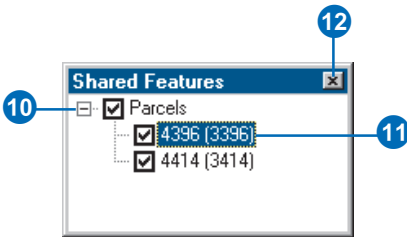

The Shared Features dialog box shows the features that share a selected topology element. This edge is shared by features 4414 and 4396 in the Parcels feature class.

- Click 4396.

The parcel flashes on the map.

- Close the Shared Features dialog box.

Next you will move the shared edge.

Moving the shared edge and nodes

The endpoints of this edge are topology nodes that are shared by these two parcels but are also shared by some other parcels. To move the endpoints of this edge, you will need to select the nodes, along with the edge, and split–move them. A split–move breaks the topological association between a selected node and unselected edges.

- Hold the N key and drag a small box around the node at the eastern end of the edge.

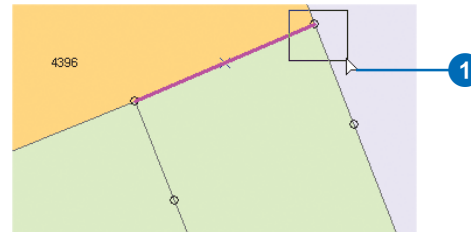

The topology node is added to the selection. Holding the N key allows you to select a topology node without selecting any more nearby edges.

2. Move the pointer over the selected node.

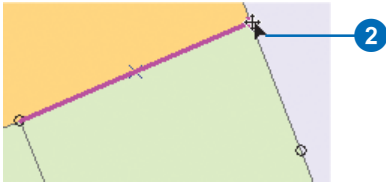

3. Press the S key with the pointer over the node.

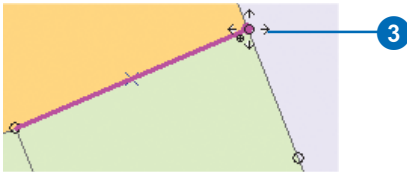

The pointer changes to indicate that you can split–move this node. A split–move breaks the topological association between the node and unselected edges and allows you to move an endpoint of an edge that is shared by other features.

4. While holding the S key, click the node and drag it southeast until it snaps to the new topology node you created, then drop the node.

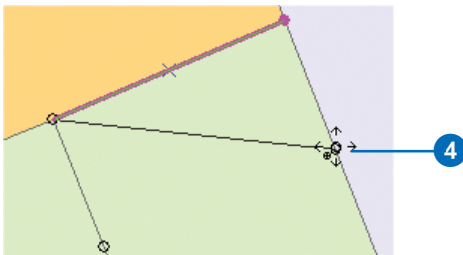

5. Hold the N key and drag a small box around the node at the western end of the edge.

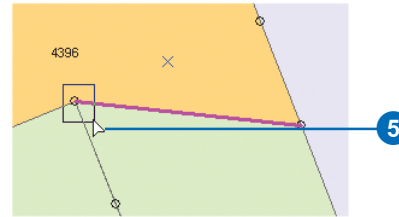

6. Move the pointer over the selected node.

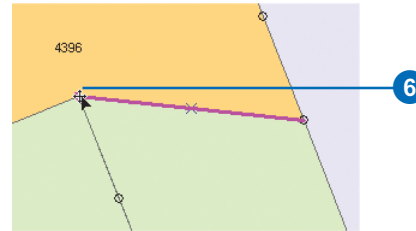

7. Press the S key with the pointer over the node.



Now you can split–move this node to the new location.

8. While holding the S key, click the node and drag it southeast until it snaps to the new topology node you created, then drop the node.

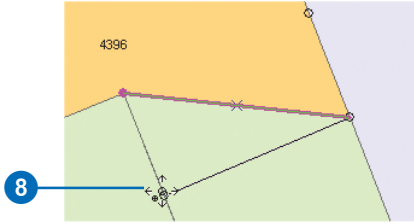

The shared parcel edge is moved to the new location. Because you split–moved the nodes at the endpoint of the edge, the corner of the parcel that did not share the edge (4420) was not modified.

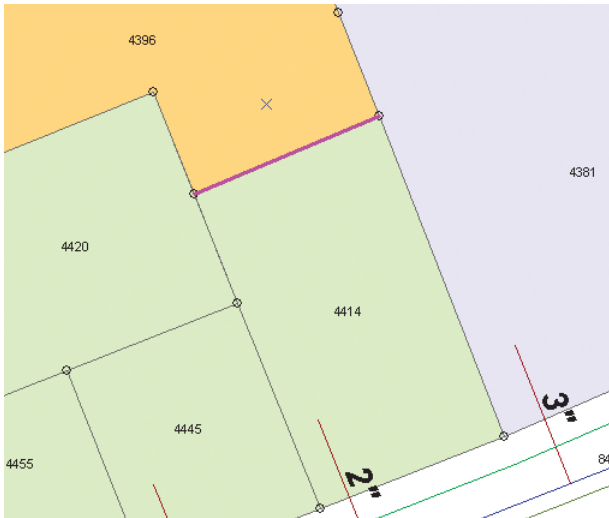

9. Click the Validate Topology In Current Extent button.



The edits you've made to the parcels are checked against the topology rules. Because no rules were violated by the edits, no errors are found.

You have edited the attributes and geometry of some geodatabase features that participate in a topology. Next you'll save your edits.

Saving your edits

Now that you've completed editing the parcels, you should save your edits.

1. Click the Editor menu and click Save Edits.

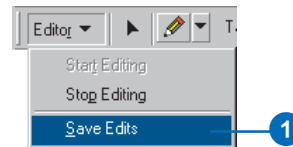

The edits are saved to the geodatabase. In the next section, you'll edit some geometric network features.

Editing geometric network features

Imagine that you work for the city water department. You've been asked to update the geodatabase to show the new position of a fire hydrant that has been moved and to add another hydrant and its associated pipes and fittings. The hydrants are connected to the city water system, which is modelled using a geometric network in the geodatabase. A geometric network is another sort of topological relationship that the geodatabase can maintain among feature classes. Just as you can edit edges and nodes shared by multiple features in a topology, a geometric network allows you to edit network edge and junction features and maintain network connectivity between them.

1. Click View, point to Bookmarks, and click EditHydrant.

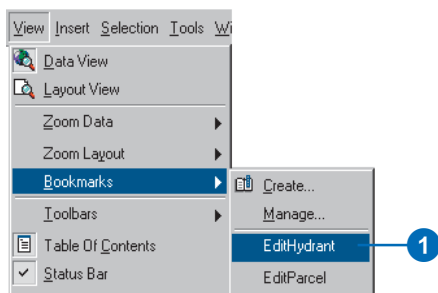

You will move the hydrant in parcel 4054 in the center of the data frame.

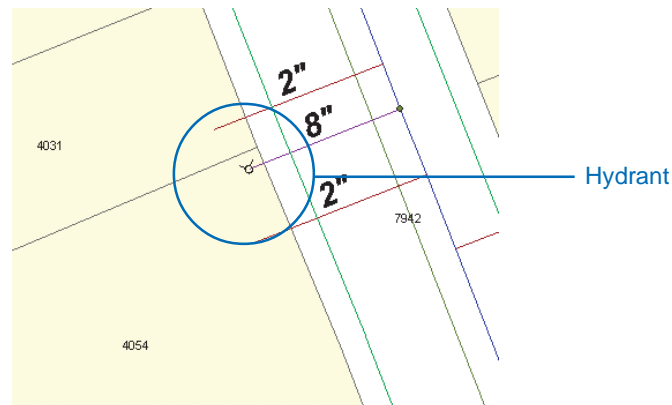

Moving a fire hydrant feature

This fire hydrant feature is a part of the geometric network. It is connected to the rest of the network by a hydrant lateral feature, a subtype of the water lateral feature class. You will see that network connectivity is maintained when the hydrant feature is moved.

First, you will change the selectable layers from all layers to Hydrants. This will make it easier to move the hydrant.

1. Click Selection and click Set Selectable Layers.

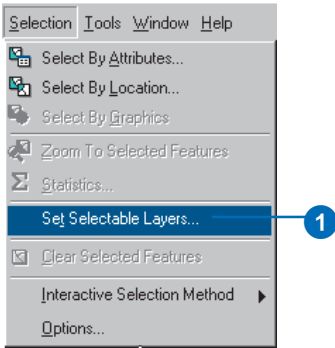

2. Click Clear All. You will change the selectable layers from all layers to only Hydrants.

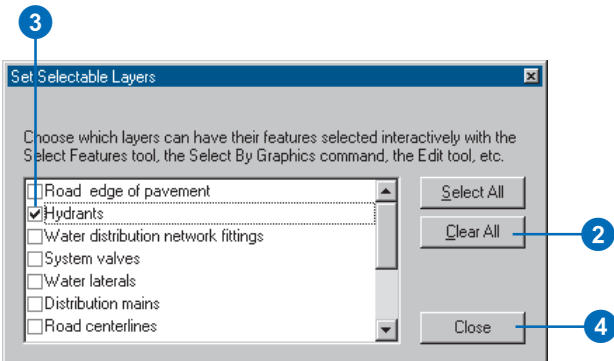

3. Check the Hydrants layer.
4. Click Close.

5. Click the Edit tool.

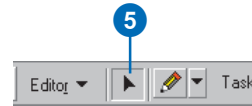

6. Drag a box around the fire hydrant.

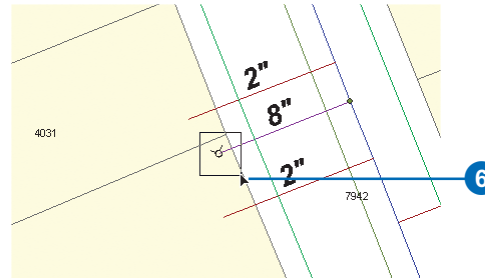

The fire hydrant should now be selected, but no other features are selected.

7. Click and drag the selected hydrant to the southwest, toward the middle of the parcel, then drop the hydrant into its new position.

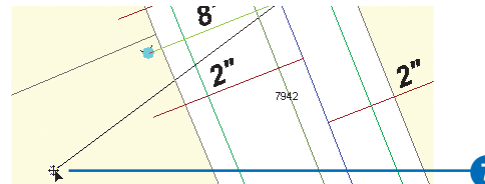

When the hydrant was moved, the lateral stretched to maintain its connectivity with both the hydrant and the valve. This is an example of how ArcGIS maintains network topology during editing.

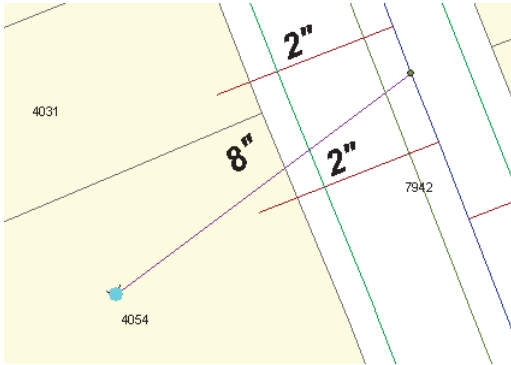

Also notice that the annotation for the lateral moved to fit the new location of the lateral. The annotation feature is linked to the lateral feature by a geodatabase relationship class.

Creating a new hydrant lateral

Now you will add a new hydrant lateral to a distribution main in the water network. This task will involve a combination of network editing, connectivity rules, attribute rules, and feature-linked annotation.

1. Click Selection and click Clear Selected Features to deselect the hydrant you just moved.

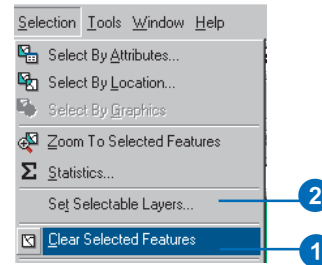

2. Click Selection and click Set Selectable Layers.
3. Uncheck Hydrants; check Distribution mains, Water laterals, and Water distribution network fittings; then close the dialog box.

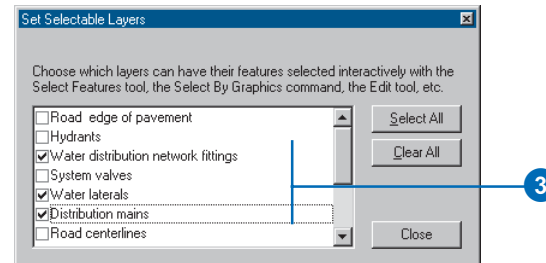

- Click the Task dropdown arrow and click Create New Feature.

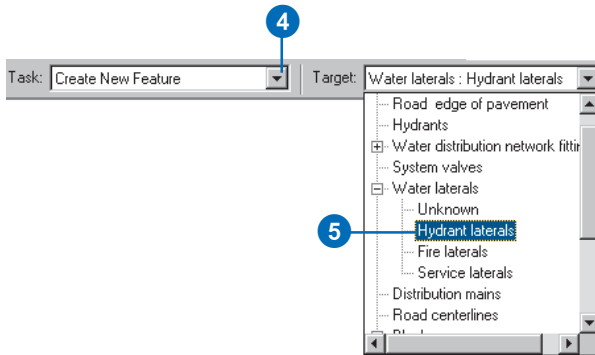

- Click the Target dropdown arrow. You will see a list of the layers in this database. The Water laterals layer has a plus sign next to it. The plus sign indicates that this layer has subtypes. Click the plus sign and click Hydrant laterals.

The new feature will be created in the Water laterals feature class and will be assigned the Hydrant Lateral subtype.

To establish network connectivity when you add your new hydrant lateral, you must snap it precisely to the distribution main.

- Click Editor and click Snapping.

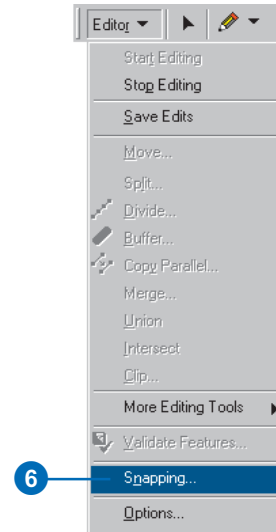

The Snapping Environment window appears. When you add the hydrant lateral, you want it to connect to a distribution main.

- Check the Edge check box next to Distribution mains and uncheck any other boxes that may still be checked. Close the Snapping Environment window.

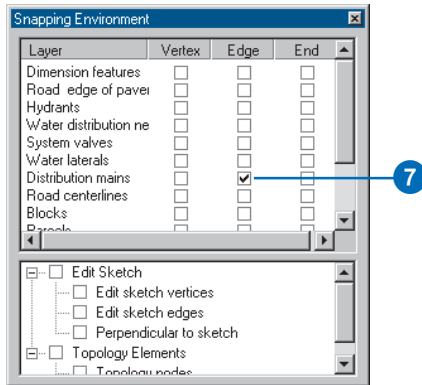

- Click the Sketch tool.

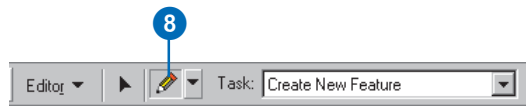

- Move the pointer over one of the distribution mains. The pointer snaps to the edge of the distribution main.

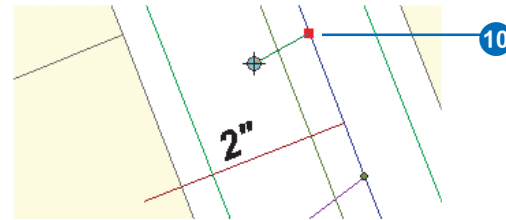
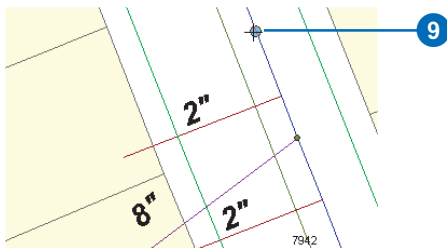

- With the pointer snapped to the main, click once to start the new hydrant lateral.

You have just started an *edit sketch*. You create an edit sketch of the geometry when you use the editor tools to create a new feature. After you finish the sketch, the new geometry becomes a feature. You can choose to save or discard your edits when you stop editing.

You will constrain the hydrant lateral to be perpendicular to the distribution main.

- Move the pointer over the distribution main just south of where you attached the lateral, right-click, and click Perpendicular.

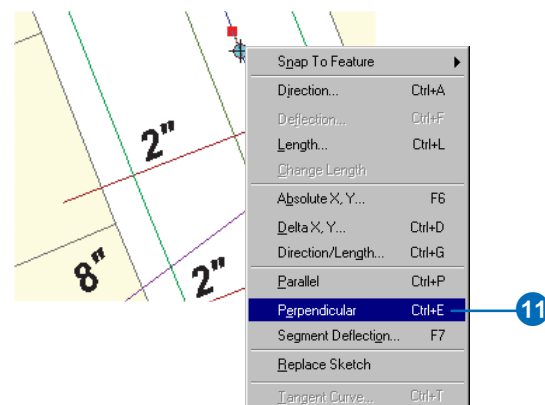

As you move the pointer, you can see that your sketch of the hydrant lateral is constrained to be perpendicular to the distribution main.

Many of the editing tools and commands have keyboard shortcuts associated with them to make editing quicker. You can see the keyboard shortcuts next to the command names in the Edit context menu and on some of the tool windows.

You will now make the lateral 65 feet long.

12. Drag the sketch line to the southwest, then press Ctrl+L. Type “65” and press Enter.

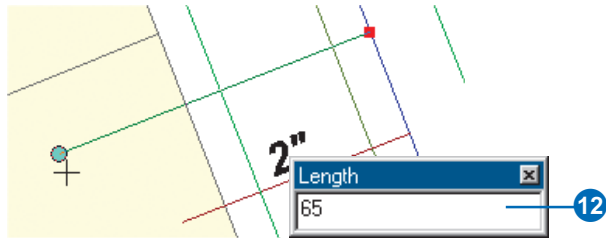

A new vertex is added to the lateral, perpendicular to the distribution main and 65 feet away.

13. Right-click and click Finish Sketch to finish the edit sketch and create the new hydrant lateral.

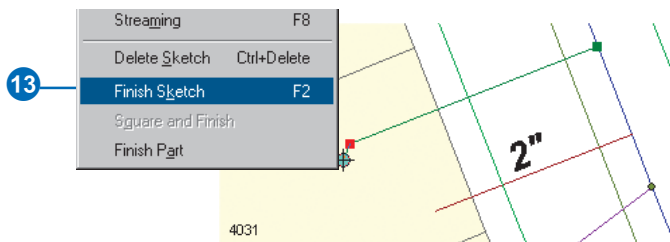

When the new hydrant lateral is created, a number of things happen.

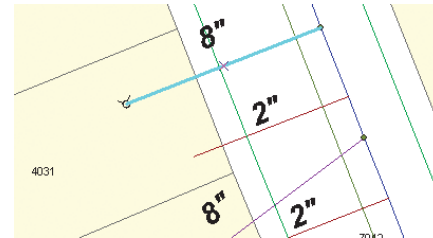

First, a junction between the distribution main and the hydrant lateral is created, and they are topologically connected in the network. The network was created with a *connectivity rule* between these feature types that specifies a default junction, so the new junction is the default junction—in this case, a tap feature.

Next, a junction feature is also added to the other end of the new hydrant lateral. Another connectivity rule exists between water laterals and hydrants. For this rule hydrants were the default junction, so the new junction feature at the southwest end of the lateral is a hydrant.

In addition, when the new hydrant lateral was added, its annotation was also added. A relationship class in the geodatabase links laterals to the LateralDiam annotation feature class. The annotation feature class was created with an advanced labeling expression that labels features longer than 200 feet with their diameter and material type. Since this lateral is less than 200 feet in length and the default value for diameter is 8 inches, the annotation text is 8".

Modifying the hydrant lateral

You'll now modify the hydrant lateral to explore some more geometric network and geodatabase behaviors.

1. Click the Edit tool.

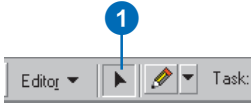

2. Click the lateral and drag it away from the distribution main, then release the mouse button to drop the lateral.

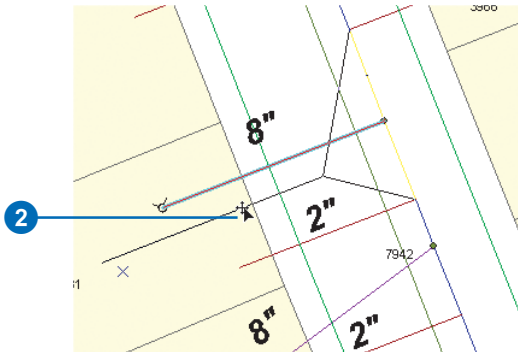

The distribution main stretches to stay connected with the lateral. The distribution main feature is a complex edge feature—it is split in the *logical network* by the addition of the lateral, but it remains a single feature in the geometric network. The annotation also moves with the feature.

3. Click the Undo button to undo the move.

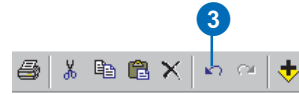

Now you will change the value for the diameter of the lateral.

4. Click the Attributes button.



The new hydrant lateral's attributes are displayed. Some of the fields already have default values that were defined in the geodatabase for this subtype of Water laterals, while other fields have null values.

5. Click the DIAMETER value.
6. Click the dropdown arrow and click 6".

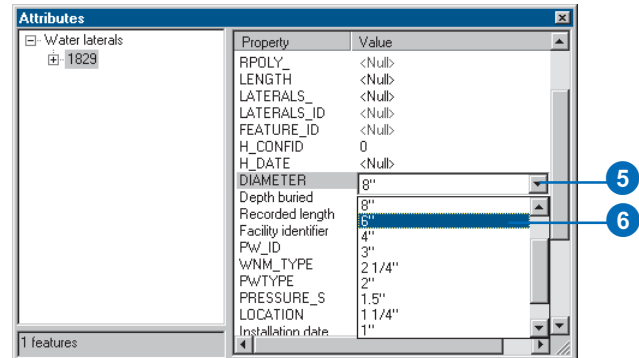

This geodatabase has a coded value domain of valid pipe diameters. The diameter field for hydrant laterals references this diameter value domain. Several different feature classes or subtypes can reference the same coded value domain.

Since the annotation for laterals is derived in part from the value of the DIAMETER field, when you clicked the new value for the diameter, the annotation was automatically updated to reflect the change.

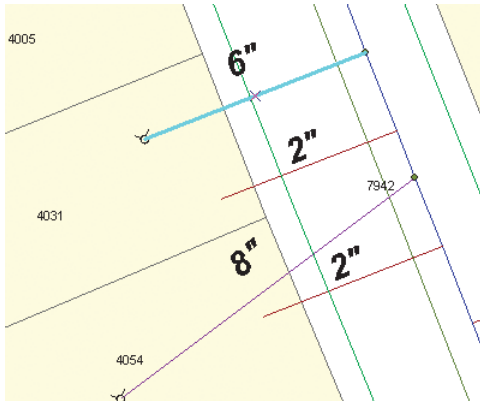

7. Close the Attributes dialog box.

Creating a new dimension feature

The water department wants the geodatabase to show how far the hydrant you added is from the one you moved. You will create a new dimension feature to display this distance. You will create this new dimension feature using the Dimensions feature class in your geodatabase.

1. Click Editor, point to More Editing Tools, and click Dimensioning.

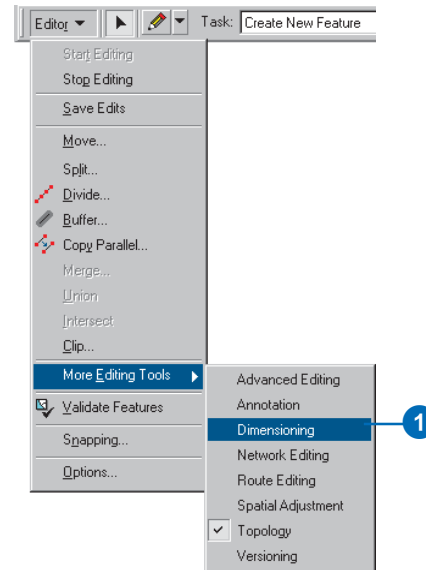

The Dimensioning toolbar lets you choose dimensioning construction methods and styles for your new dimension features.

- Click the Target layer dropdown arrow on the Editor toolbar and click Dimension features.

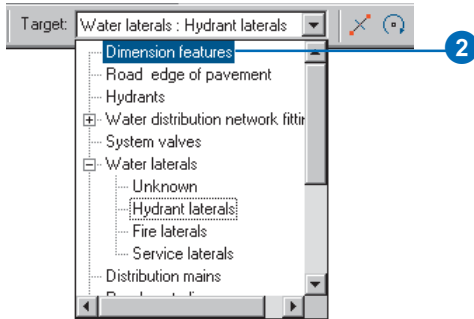

The Dimensioning toolbar becomes active.



You will use the Aligned construction method to construct an aligned dimension feature. This is the default construction method, though there are several others available. Since you are dimensioning features in your water network, you will use the Water dimensions style.

- Click the Style dropdown arrow; the dimension styles in the Dimensions feature class are listed. Click the Water dimensions style.

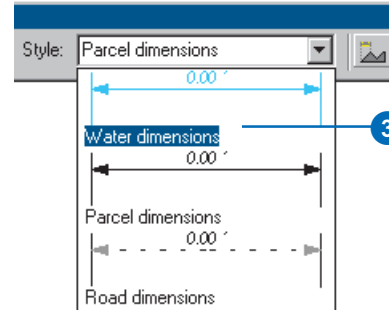

- Click the Editor menu and click Snapping.



The Snapping Environment window appears. Since you are creating a dimension feature to display the length between two hydrants, you need to set your snapping to the vertices of hydrants.

5. Check Vertex next to Hydrants.

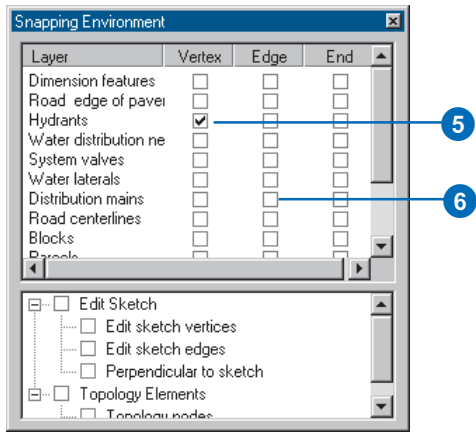

6. Uncheck Edge next to Distribution mains, then close the Snapping Environment window.
7. Click the Sketch tool.

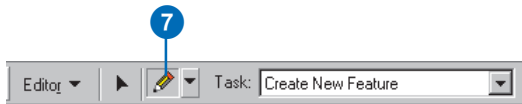

8. Move the pointer over one of the hydrants. The pointer snaps to the hydrant.

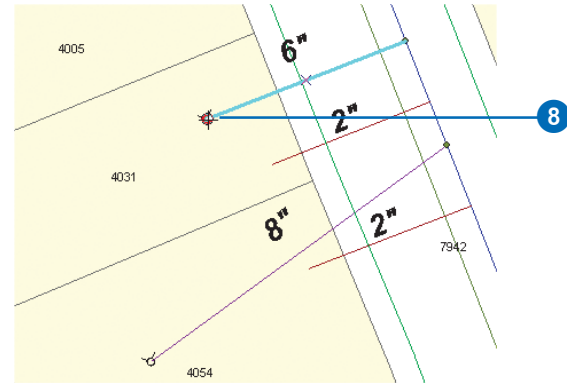

9. With the pointer snapped to the hydrant, click once to start an edit sketch.
10. Move the pointer over the other hydrant.

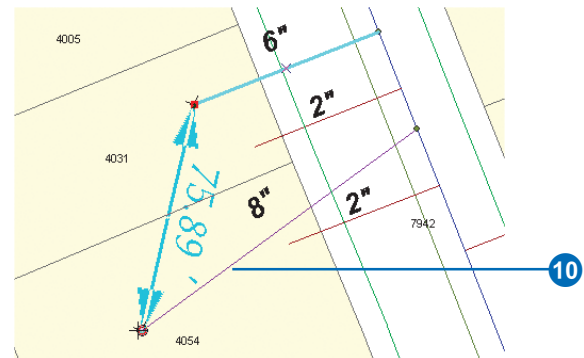

As you move the pointer, the edit sketch draws a preview of the first part of the dimension feature and updates its length.

11. With the pointer snapped to the second hydrant, click once.
12. Move the pointer away from the hydrant.

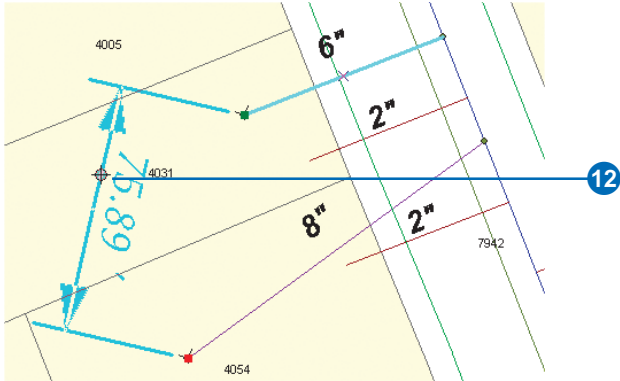

As you move the pointer, the dimension feature's height changes.

13. When you have dragged the dimension feature to the height you want, click once.

Since you are using the Aligned construction method, the sketch is automatically finished after the three points are input and your dimension feature is finished. You can save your edits and your map document if you want.

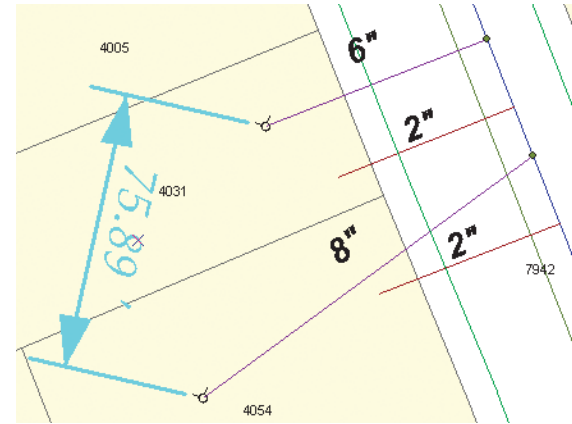

In this quick-start tutorial, you have used ArcMap to take advantage of advanced geodatabase capabilities, including topology, geometric networks, relationship classes, feature subtypes, attribute domains, default values, feature-linked annotation, and dimension features.

The next section of this workbook contains exercises to help you learn how to use ArcMap to edit features. The last section of the book contains exercises to help you learn how to construct a geodatabase with the advanced capabilities you've worked with in this quick-start tutorial.