

ArcGIS® 9

ArcGIS Spatial Analyst Tutorial



Copyright © 2001-2006 ESRI.

All Rights Reserved.

Printed in the United States of America.

The information contained in this document is the exclusive property of ESRI. This work is protected under United States copyright law and other international treaties and conventions. No part of this work may be reproduced or transmitted in any form or by any means, electronic or mechanical, including photocopying and recording, or by any information storage or retrieval system, except as expressly permitted in writing by ESRI. All requests should be sent to Attention: Contracts and Legal Services Manager, ESRI, 380 New York Street, Redlands, CA 92373-8100, USA. The information contained in this document is subject to change without notice.

DATA CREDITS

Tutorial datasets: Courtesy of the state of Vermont

AUTHOR

Jill Willison

U. S. GOVERNMENT RESTRICTED/LIMITED RIGHTS

Any software, documentation, and/or data delivered hereunder is subject to the terms of the License Agreement. In no event shall the U.S. Government acquire greater than RESTRICTED/LIMITED RIGHTS. At a minimum, use, duplication, or disclosure by the U.S. Government is subject to restrictions as set forth in FAR §52.227-14 Alternates I, II, and III (JUN 1987); FAR §52.227-19 (JUN 1987) and/or FAR §12.211/12.212 (Commercial Technical Data/Computer Software); and DFARS §252.227-7015 (NOV 1995) (Technical Data) and/or DFARS §227.7202 (Computer Software), as applicable. Contractor/Manufacturer is ESRI, 380 New York Street, Redlands, CA 92373-8100, USA.

DISCLAIMER

THE DATA INCLUDED IN THIS WORK IS FROM AN INDEPENDENT COMPANY AND, AS SUCH, ESRI MAKES NO GUARANTEES AS TO THE QUALITY, COMPLETENESS, AND/OR ACCURACY OF THE DATA. EVERY EFFORT HAS BEEN MADE TO ENSURE THE ACCURACY OF THE DATA INCLUDED IN THIS WORK, BUT THE INFORMATION IS DYNAMIC IN NATURE AND IS SUBJECT TO CHANGE WITHOUT NOTICE. ESRI AND THE DATA VENDOR(S) ARE NOT INVITING RELIANCE ON THE DATA, AND ONE SHOULD ALWAYS VERIFY ACTUAL DATA AND INFORMATION. ESRI DISCLAIMS ALL OTHER WARRANTIES OR REPRESENTATIONS, EITHER EXPRESSED OR IMPLIED, INCLUDING, BUT NOT LIMITED TO, THE IMPLIED WARRANTIES OF MERCHANTABILITY OR FITNESS FOR A PARTICULAR PURPOSE. ESRI AND THE DATA VENDOR(S) SHALL ASSUME NO LIABILITY FOR INDIRECT, SPECIAL, EXEMPLARY, OR CONSEQUENTIAL DAMAGES, EVEN IF ADVISED OF THE POSSIBILITY THEREOF.

ESRI, the ESRI globe logo, ArcGIS, the ArcGIS logo, ArcView, ArcEditor, ArcInfo, ArcMap, ArcCatalog, ArcScene, ArcGlobe, ArcToolbox, ModelBuilder, and www.esri.com are trademarks, registered trademarks, or service marks of ESRI in the United States, the European Community, or certain other jurisdictions.

Other companies and products mentioned herein are trademarks or registered trademarks of their respective trademark owners.

ArcGIS Spatial Analyst Tutorial

IN THIS TUTORIAL

- **Exercise 1: Preparing for analysis**
- **Exercise 2: Finding a site for a new school**
- **Exercise 3: Finding an alternate access route to the new school site**

Using the Spatial Analyst tools available with ESRI® ArcGIS®, you can easily perform spatial analysis on your data. You can provide answers to simple spatial questions, such as how steep is it at this location? or what direction is this location facing? You can also find answers to more complex spatial questions, such as where is the best location for a new facility? or what is the least costly path from A to B? The comprehensive set of Spatial Analyst tools within ArcGIS allows you to explore and analyze your spatial data and enables you to find solutions to your spatial problems. You can run tools from the Spatial Analyst toolbox or the command line, accessible via any ArcGIS Desktop application, or you can run tools from the Spatial Analyst toolbar in ArcMap™. You can also create your own custom tools (models or scripts) to run a sequence of tools at one time.

Tutorial scenario

The town of Stowe, Vermont, USA, has experienced a substantial increase in population. Demographic data suggests this increase has occurred because of families with children moving to the region, taking advantage of the many recreational facilities located nearby. It has been decided that a new school must be built to take the strain off the existing schools, and as a town planner, you have been assigned the task of finding the potential site.

This tutorial will show you how to use many of the available tools and will give you a solid basis from which you can start to think about how to solve your own specific spatial problems.

It is assumed that you have installed ArcGIS Desktop (ArcView®, ArcEditor™, or ArcInfo®) and the ArcGIS Spatial Analyst extension before you begin this tutorial. In ArcGIS 8, you accessed Spatial Analyst tools from the Spatial Analyst toolbar in ArcMap. In ArcGIS 9, you can still use the Spatial Analyst toolbar but you can also run tools from the Spatial Analyst toolbox. You'll access tools in the toolbox from the ArcToolbox™ window. The ArcToolbox window can be docked in any ArcGIS Desktop application, meaning you can run Spatial Analyst tools in applications such as ArcCatalog™, ArcScene™, or ArcGlobe™.

The data required is included on the ArcGIS Desktop CD. After running the ArcGIS setup, on the Additional Installation Components dialog box, check to install the ArcGIS Tutorial Data. On the ArcGIS Tutorial Data Setup wizard, check to install the Spatial Analyst data (the default installation path is C:\arcgis\ArcTutor\Spatial). The datasets were provided courtesy of the state of Vermont for use in this tutorial. The tutorial scenario is fictitious, and the original data has been adapted for the tutorial.

The datasets are:

Dataset	Description
Elevation	Raster dataset representing the elevation of the area
Landuse	Raster dataset representing the land-use types over the area
Roads	Feature class representing the linear road network for the town of Stowe
Rec_sites	Feature class representing point locations of recreation sites

Schools	Feature class representing point locations of existing schools
Destination	Feature class representing the destination point used when finding the best route for a new road

This tutorial is divided into exercises and is designed to allow you to explore the Spatial Analyst functionality in ArcGIS at your own pace.

- In exercise 1, you'll prepare for analysis. You'll copy the tutorial data locally and create a folder and a geodatabase to hold your results. You'll learn the location of the Spatial Analyst tools, create a hillshade output, and explore your data.
- In exercise 2, you'll create a suitability map to help you find the best location for a new school. You'll derive datasets of distance and slope, reclassify datasets to a common scale, then weight those that are more important to consider and combine them to find the most suitable locations. You'll then locate the optimal site using the selection tools within ArcMap.
- In exercise 3, you'll find the least costly route for an alternate access road to the new school site.

You will need approximately 90 minutes of focused time to complete the tutorial. Alternatively, you can perform the exercises in sequence one at a time, saving your results along the way when recommended.

Exercise 1: Preparing for analysis

In this exercise, you'll prepare for analysis by first copying the tutorial data locally, then creating a folder and a geodatabase for your results. You'll locate the Spatial Analyst tools and create a hillshade output to display transparently with your other layers. You'll explore your input data and open the ArcToolbox window. This exercise will take approximately 15 minutes to complete.

Organizing your data

Before working with Spatial Analyst tools, you'll organize your tutorial data using ArcCatalog.

Starting ArcCatalog

1. Start ArcCatalog by either double-clicking a shortcut installed on your desktop or using the Programs list On the Start menu.

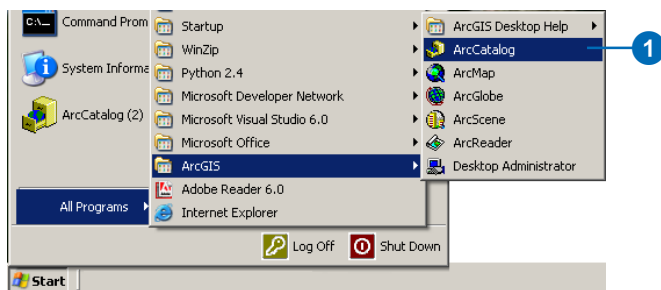

Locating the tutorial data

By connecting to a folder in ArcCatalog, you can quickly see the folders and data sources it contains. You'll now begin organizing your tutorial data by establishing a folder connection to its location.

1. Click the Connect To Folder button.

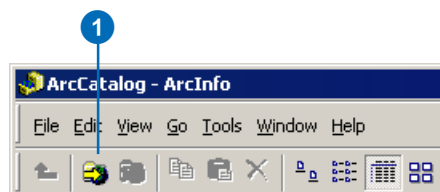

2. Type the pathname or navigate to the location where you installed the tutorial data; for example, if you installed ArcGIS on your C:\ drive, type "C:\arcgis\ArcTutor\Spatial", then click OK to establish a folder connection.

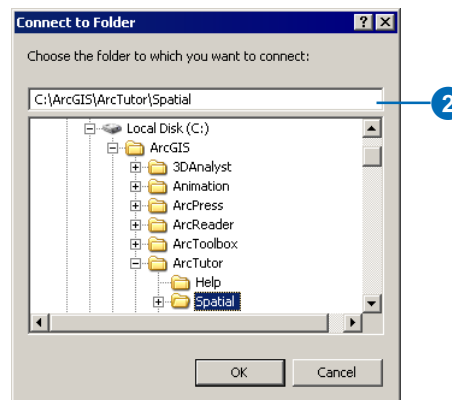

Your new folder connection to the tutorial data is listed in the ArcCatalog tree.

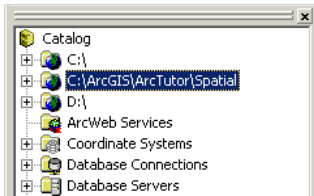

Creating a working copy of the tutorial data

You'll now copy the tutorial data into a folder on a local disk to maintain the integrity of the original data. Once it has been copied, you will create a connection to the folder containing the data.

1. Click the connection to the tutorial data (for example, C:\arcgis\ArcTutor\Spatial), then click the Contents tab and click landuse, elevation, and the file geodatabase Stowe.gdb.
2. Click the Copy button on the Standard toolbar.

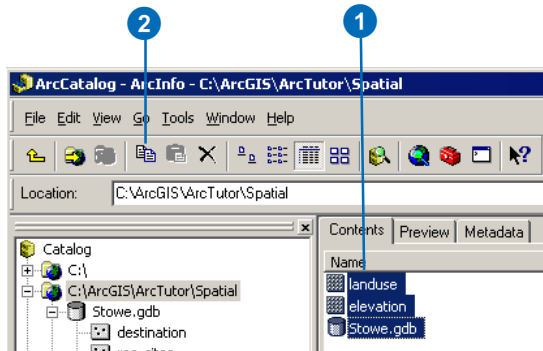

3. Right-click the C:\ (or an alternative drive) folder connection in the ArcCatalog tree, point to New, then click Folder.

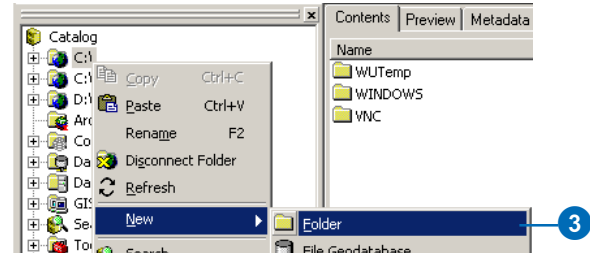

4. Rename the created folder "Spatial", then press Enter.
5. Double-click the Spatial folder and click the Paste button on the Standard toolbar to paste the copied datasets and geodatabase into it.



6. Click the Connect To Folder button again, create a connection to your Spatial folder, then click OK.

Your new folder connection, for example, C:\Spatial, is now listed in the Catalog tree. You will access this connection many times during this tutorial.

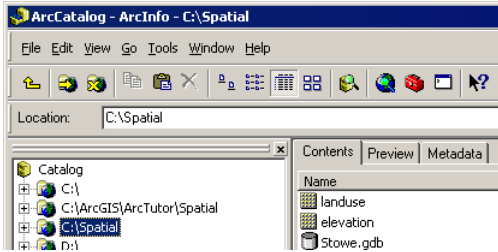

Creating a folder and a geodatabase for results

In the next exercise, you'll build a model that will help you locate areas suitable for building a new school. You'll need a folder to hold the majority of your results. You'll also need a file geodatabase to hold feature classes you'll create.

Creating a new folder

First you'll create a Results folder. This folder will hold results from your model in the next exercise.

1. Right-click the connection to your Spatial folder in the ArcCatalog tree, point to New, then click Folder.

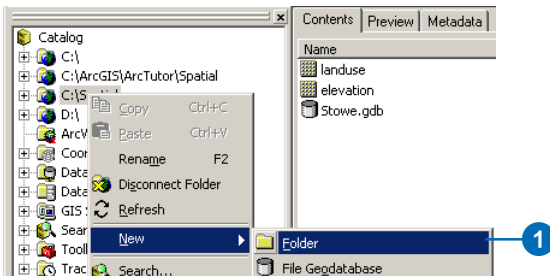

2. Change the name of the folder to "Results" and press Enter.

Creating a new file geodatabase

You'll now create a file geodatabase within the Results folder. This geodatabase will hold feature class results from your model in the next exercise.

1. Right-click the Results folder, point to New, then click File Geodatabase.

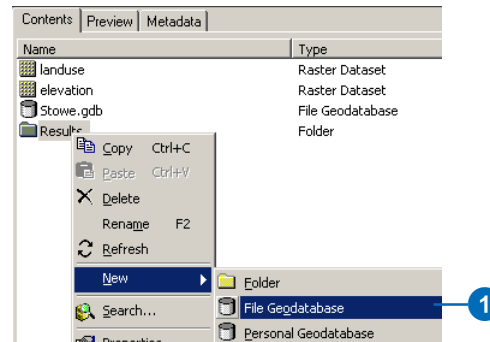

2. Rename the geodatabase "Site" and press Enter.

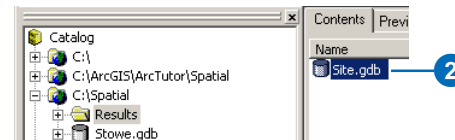

3. Click File on the Main Menu and click Exit to end the ArcCatalog session.

Starting ArcMap

1. Start ArcMap by either double-clicking a shortcut installed on your desktop or using the Programs list on the Start menu.
2. If the ArcMap startup dialog box appears, click OK to open a new empty map.

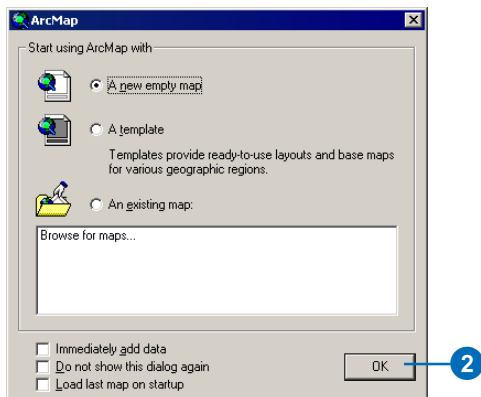

Adding data to your ArcMap session

1. Click the Add Data button on the Standard toolbar.



2. Navigate to the folder on your local drive where you copied the tutorial data (for example, C:\Spatial).
3. Double-click Stowe.gdb, press and hold down the Shift key, then select all the feature classes.

4. Click Add.

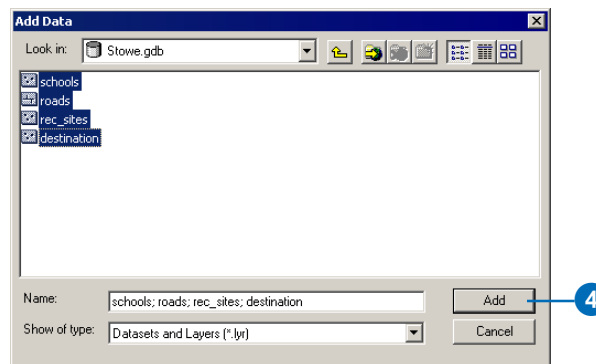

The feature classes are added to the ArcMap table of contents as layers.

5. Click the Add Data button again and click Up One Level to navigate to the folder on your local drive where you copied the tutorial data (for example, C:\Spatial).
6. Click landuse, hold down the Ctrl key, then click elevation.
7. Click Add.

Checking out a Spatial Analyst license

1. Click the Tools menu and click Extensions.

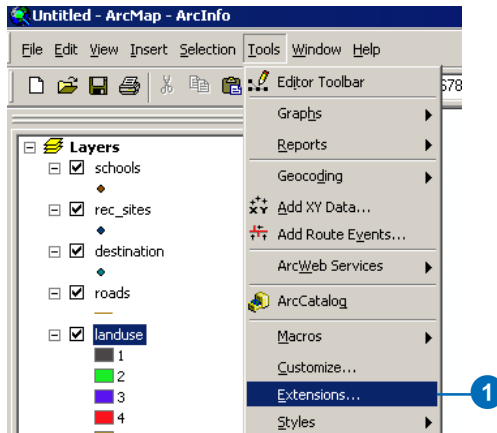

2. Check the Spatial Analyst check box.

3. Click Close.

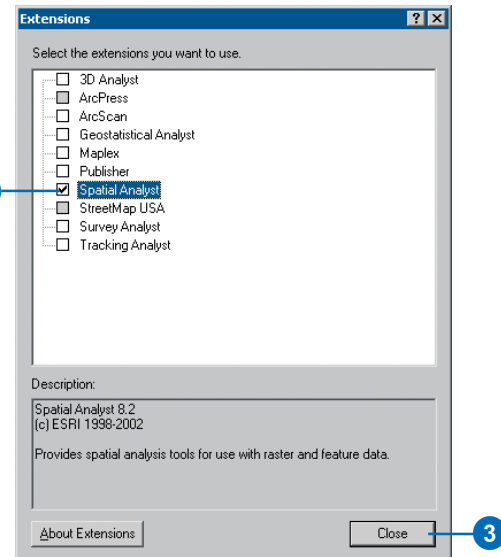

Adding the Spatial Analyst toolbar

1. Click View on the Main Menu, point to Toolbars, then click Spatial Analyst.

The Spatial Analyst toolbar is added to your ArcMap session.



Creating a hillshade

You'll start by using the Spatial Analyst toolbar. You'll run the Hillshade tool so you can view and explore the output from this tool with the rest of your input data later in this exercise. A hillshade is a shaded relief raster created by taking an elevation raster and setting an illumination source (for example, the sun) at a user-specified azimuth (the angular direction of the illumination source, in positive degrees from 0 to 360) and altitude (the angle of the illumination source above the horizon). The visual effect of a hillshade can be dramatic when it is displayed under other transparent layers in your ArcMap display.

1. Click the Spatial Analyst drop-down arrow, point to Surface Analysis, then click Hillshade.

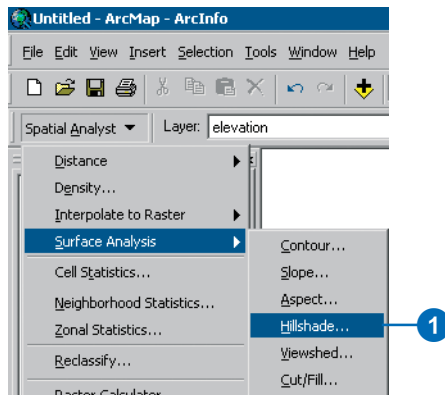

2. Click the Input surface drop-down arrow and click elevation.
3. You'll accept the default values set for the Azimuth and Altitude parameters, since these values provide optimal results when using a hillshade for display purposes.
4. You'll also accept the default and leave Model shadows unchecked, so the local illumination of the surface will be calculated whether or not a cell falls in the shadow of another cell.

If your x-, y- and z-values are all in the same unit of measure (for example, if they are all in meters), you can accept the default x-factor of 1, so the z units are not converted. The x,y units in the elevation data, however, are in meters, and the z-values (the elevation values) are in feet. By multiplying the z-values by a z-factor of 0.3048, they will be converted to meters, since there are 0.3048 meters in one foot.

Note: Setting an appropriate z-factor is critical for good results if your input surface is stored in a geographic coordinate system (for example, the x,y units are a spherical measurement, such as decimal degrees or decimal seconds). Type “Hillshade tool/command” into the index of the ArcGIS Desktop Help system for an explanation of suitable z-factors. The z-factor can also be used for exaggeration of the terrain.

5. Type a value of “0.3048” for the Z factor parameter.
6. The cell size (value of 30 meters) of the input dataset will be used for the output cell size, since environment settings have not been specified on the Options dialog box (accessed via the Spatial Analyst toolbar context menu).

7. Instead of creating a temporary raster output, click in the Output raster text box and remove the default text <temporary>.
8. Type the pathname to your Results folder (for example, "C:\Spatial\Results\") and type "hillshd" for the name of the output.

A permanent result will be created.

9. Click OK to run the tool.

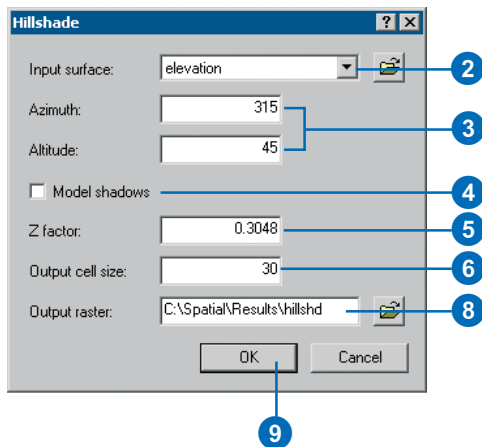

10. In the table of contents, click and drag the hillshade result below landuse.
11. Uncheck the elevation layer in the table of contents.

Displaying and exploring data

You will now explore the display capabilities of ArcMap by changing the symbology of one of the layers and applying transparency so you can see the hillshade output you have created underneath your other layers in the display.

1. Right-click landuse in the table of contents and click Properties.

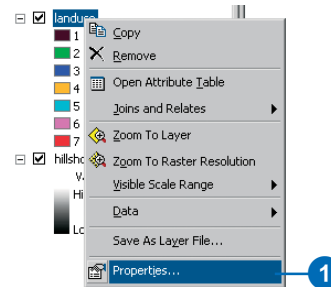

2. Click the Symbology tab.

All land-use categories are currently drawn using the field Value and in random colors. You will change the Value Field setting to be more meaningful and change the color of each symbol to show a more appropriate color for each land-use type on the map.

3. Click the Value Field drop-down arrow and click LANDUSE. This is a string field in the land-use attribute table that describes each land-use type.
4. Double-click each symbol and choose a suitable color to represent each land-use type (for example, water should be blue).
5. Click OK.

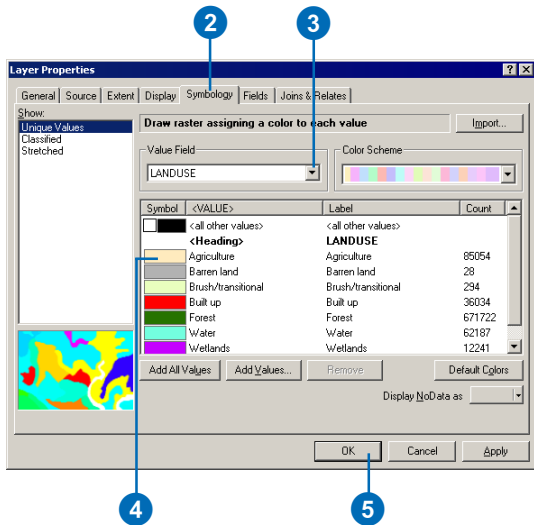

The changes you make are reflected in the table of contents and in the map display.

- Click View on the Main Menu, point to Toolbars, then click Effects.

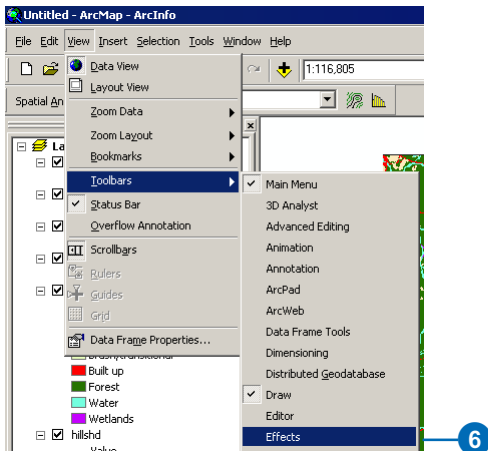

- Click the Layer drop-down arrow and click landuse.
- Click the Adjust Transparency button and move the Transparency slider to 30 percent transparency.

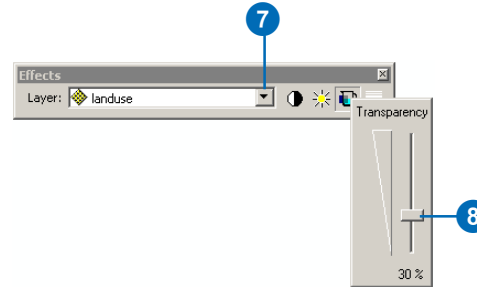

The hillshd layer can now be seen underneath the landuse layer, giving a vivid impression of the terrain.

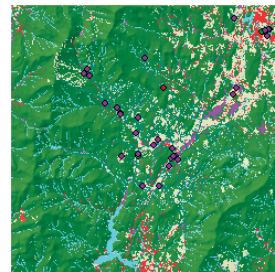

Highlighting a selection on the map

Examining the Attribute Table gives you an idea of the number of cells of each attribute in the dataset.

- Right-click landuse in the table of contents and click Open Attribute Table.

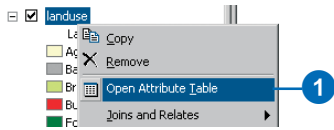

The COUNT field identifies the number of cells in the dataset of each value. Notice that Forest (value of 6) has the largest count, followed by Agriculture (value of 5), then Water (value of 2).

2. Click the row representing Wetlands (value of 7).
This selected set, all areas where the land-use is Wetlands, is highlighted on the map.
3. Click Options, then click Clear Selection.
4. Click the Close button to close the Attributes of landuse table.

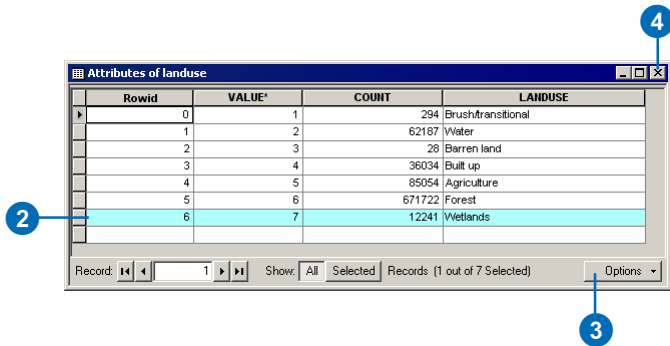

Identifying features on the map

1. Click the Identify tool on the Tools toolbar.

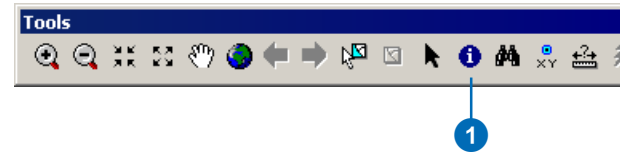

2. Click the Identify from drop-down arrow on the Identify dialog box and click <All layers>.
3. Click the rec_site in the location shown to identify the features in this particular location.

Note: Your display will not be zoomed in this much; this is only to show the location of the recreation site to click.

4. Expand each layer to obtain the value for each layer in this location.
5. Close the Identify dialog box.

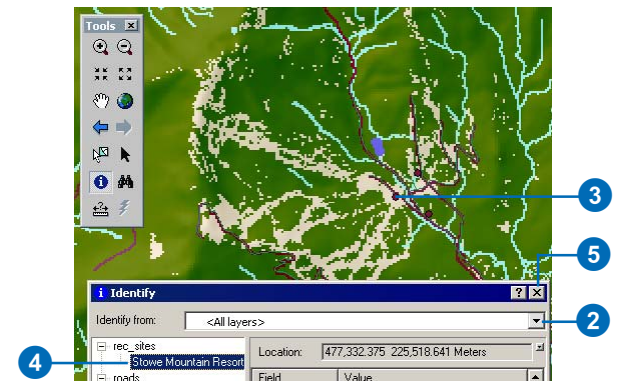

Examining a histogram

1. On the Spatial Analyst toolbar, click the Layer drop-down arrow and click landuse.
2. Click the Histogram button.



The histogram displays the number of cells of each type of land use.

Since no cell size has been specified on the Cell Size tab of the Options dialog box, the default takes the cell size of the input—25 meters in this case. If the cell size set on the Options dialog box was larger, there would be less cells of each land-use type, but each cell would cover a larger area.

3. Close the histogram.

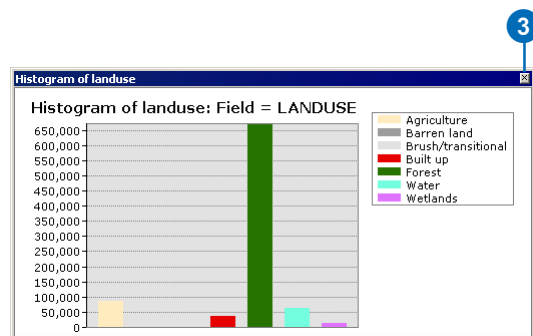

Opening the ArcToolbox window

In addition to accessing tools from the Spatial Analyst toolbar, you can access similar tools, and many more of them, from the ArcToolbox window.

1. Click the Show/Hide ArcToolbox Window button on the Standard toolbar to open the ArcToolbox window.

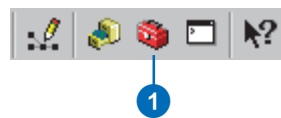

The window is placed within the application. Its position may vary depending on the windows you have open.

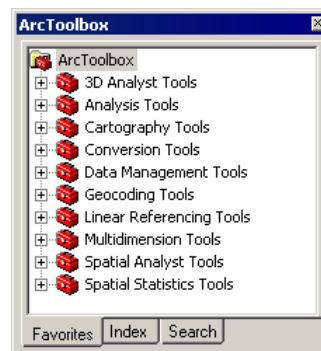

From the ArcToolbox window, you can access all the geoprocessing tools available with ArcGIS. There are more than 450 tools, including more than 150 Spatial Analyst tools contained within the Spatial Analyst Tools toolbox. All tools can be run via dialog boxes or a command line.

Docking the ArcToolbox window

The ArcToolbox window can be placed anywhere in the application or on the desktop outside the ArcMap window.

1. Click and drag the bar at the top of the ArcToolbox window.
2. Place the ArcToolbox window over the ArcMap table of contents, then release the mouse button to drop the panel. The outline of the ArcToolbox window helps you place it in the desired position.

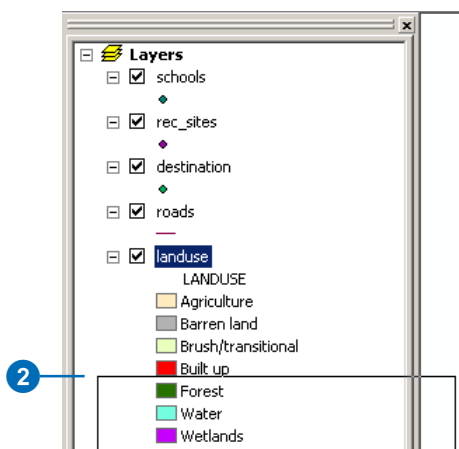

Saving the map document

As the last step in this exercise, you'll save the map document. You'll use this map document in the next exercise.

1. Click File, then click Save As.

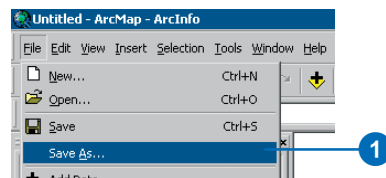

2. Navigate to your Spatial folder and type "Site_Analysis.mxd" for the File name.
3. Click Save.

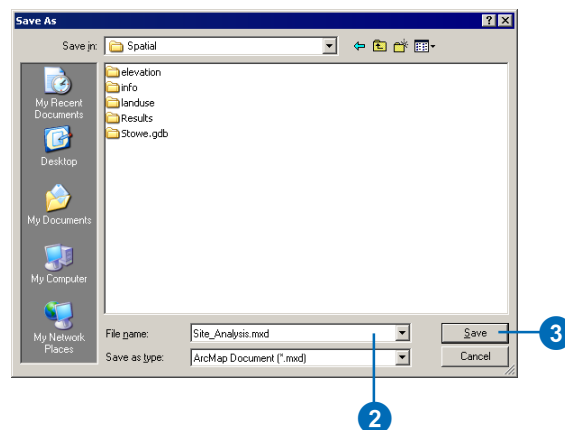

In this exercise, you copied the tutorial data locally and explored it, learned how to access Spatial Analyst tools, and learned how to run them from the Spatial Analyst toolbar. In the next exercise, you'll build a model by adding tools from the Spatial Analyst Tools toolbox to a ModelBuilder™ window to run a sequence of tools that will locate the areas that are suitable for building a new school.

You can proceed to exercise 2 or stop and complete the tutorial at a later time. If you do not proceed to exercise 2 now, do not delete your working copy of the tutorial data or the folder connection that accesses it in ArcCatalog.

Exercise 2: Finding a site for a new school

In this exercise, you will build a suitability model that finds suitable locations for a new school. The steps to produce such a suitability model are outlined below.

Your input datasets in this exercise are landuse, elevation, rec_sites, and schools. You will derive slope, distance to recreation sites, and distance to existing schools, then reclassify these derived datasets to a common scale from 1 to 10. You'll weight them and the landuse dataset according to a percentage of influence and combine them to produce a map displaying suitable locations for the new school. You'll then select the optimal site for the new school from the alternatives.

This exercise will take approximately 45 minutes to complete.

Setting up

If you are continuing from the previous exercise and have the Site Analysis map document open, go to the next section, 'Creating a new toolbox'.

1. Start ArcMap by either double-clicking a shortcut installed on your desktop or using the Programs list on the Start menu.
2. Click C:\Spatial\Site Analysis.mxd in the Browse for maps list to open the map document created in the previous exercise, or click Open on the Standard toolbar to navigate to the map document.
3. Click the Show/Hide ArcToolbox button on the Standard toolbar to open the ArcToolbox window if it is not present.

Creating a new toolbox

You'll first create a new toolbox to hold the models you will create in this exercise and the next one.

The default location for new toolboxes created in the ArcToolbox window is generally \Documents and Settings\yourlogin\Application Data\ESRI\ArcToolbox\My Toolboxes. You'll change this path to be your Spatial\Results folder.

1. Click Tools and click Options.

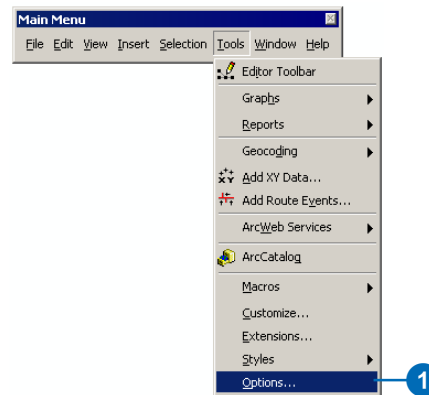

2. Click the Geoprocessing tab.
3. Type “C:\Spatial\Results” (or an alternative drive) for the location of the My Toolboxes folder.

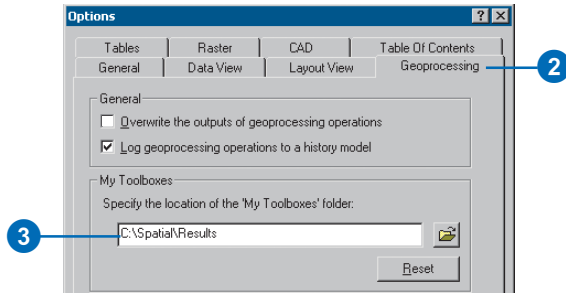

4. Click OK.
All toolboxes created in the ArcToolbox window within ArcMap will be created in this location.
5. Right-click the ArcToolbox window and click New Toolbox.

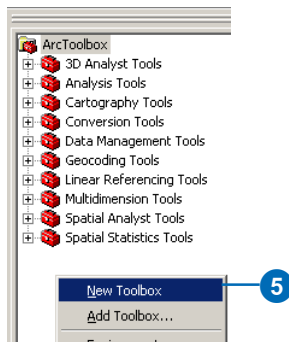

6. Change the default name for the toolbox to “Site Analysis Tools”, then press Enter.

7. Right-click the Site Analysis Tools toolbox and click Properties.

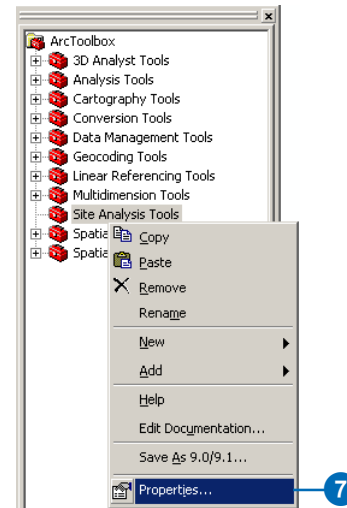

8. Check that the location of the toolbox on disk is your Results folder.
9. Click OK.

Creating a new model

You can perform your Spatial Analyst tasks by opening tool dialog boxes, supplying values for parameters, and clicking OK to run each tool, one after another. Alternatively, you can run tools at a command line. For information on running tools at the command line, type “command line” in the index of the ArcGIS Desktop Help system. If you intend to run a sequence of tools, experiment with parameter values to achieve the desired result, or to package your methodology so others can apply it to their data, you should build a model. A model is built by stringing tools together inside a

ModelBuilder window. Once your model is created, you can easily experiment with parameter values, use different input data, run the model over and over again, and share it with others.

In this exercise, you will create a model to find a suitable location for a new school.

1. Right-click the Site Analysis Tools toolbox, point to New, and click Model.

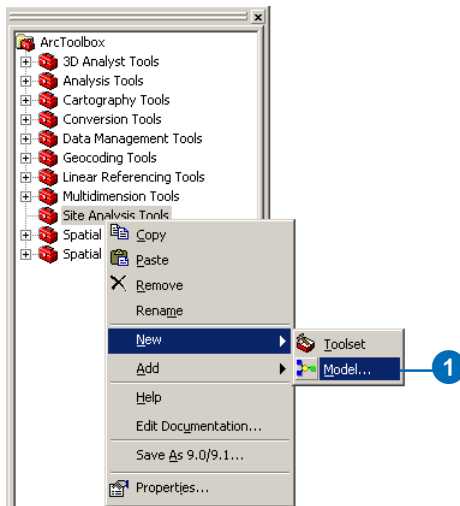

An empty ModelBuilder window will open.

Renaming the model

1. Click the Model menu and click Model Properties.

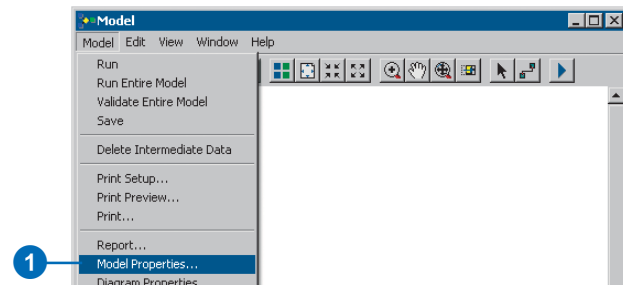

2. Click the General tab.
3. Type “find_site” in the Name text box and “Find location for school” in the Label text box. The name is used in scripting and at the command line. The label is the display name for the model.
4. Check the Store relative path names (instead of absolute paths) check box so that all paths for sources of information referenced by the tool are saved relative to the location of the toolbox. If the toolbox and its data are moved, paths to data sources will be altered accordingly.

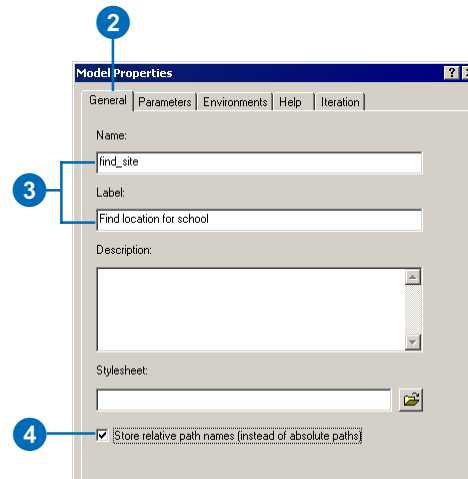

Specifying environment settings

Before you start to perform analysis on your data, you should set any relevant environment settings.

When running tools via the Spatial Analyst toolbar, you'll set environment settings on the Options dialog box (accessed via the Spatial Analyst toolbar's context menu). When working with tools via the Spatial Analyst Tools toolbox, you'll set environment settings via the Environment Settings dialog box. Although they have similar properties, the Spatial Analyst toolbox Options environment settings and the ArcToolbox environment settings do not share information or interact.

There are three levels at which you can set environment settings when working with tools in the Spatial Analyst Tools toolbox. You can specify environment settings for the application that will apply to all tools (right-click the ArcToolbox window and click Environments to access the Environment Settings dialog box). Alternatively, you can set environment settings for a specific model or for a process within a model (right-click the tool element of a process in a model and click Properties to override environment settings for a model or the application). Environment settings for the application are used by default unless they are specified for a model or for a process within a model. Settings for a model will override settings for the application. Settings for a process will override settings for the application and the model to which the process belongs. For more information on environment settings, type "environment settings" in the index of the ArcGIS Desktop Help system.

Because your environment settings apply to each process of this model only, you'll set environment settings for the model.

1. Click the Environments tab.
2. Expand the General Settings tree.
3. Check Current Workspace, Extent, and Scratch Workspace.
4. Expand the Raster Analysis Settings tree.
5. Check Cell Size.
6. Click Values.

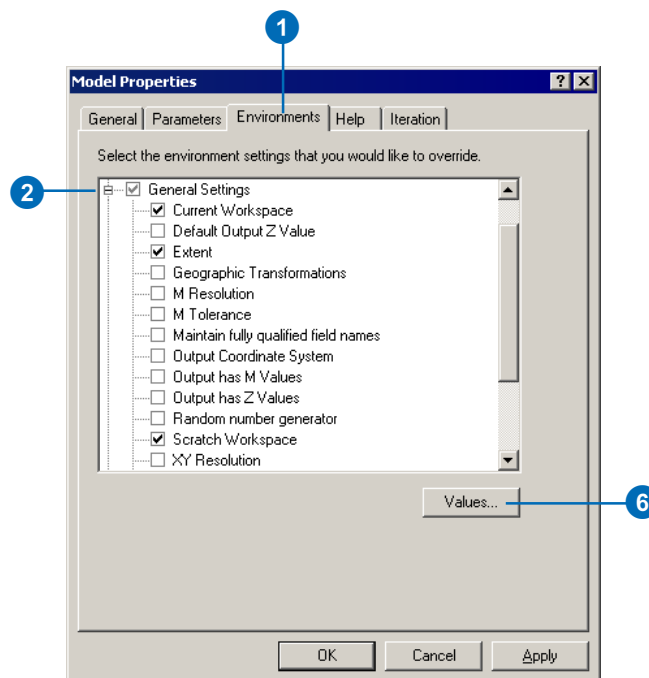

7. Expand the General Settings section of the Environment Settings dialog box.
8. In the Current Workspace text box, type the pathname to your Spatial folder—for example, “C:\Spatial”—for its value. Alternatively, click the browse button to the right of the Current Workspace text box and navigate to this location. The current workspace is the location of your project data.
9. In the Scratch Workspace text box, type the pathname to your Results folder—for example, “C:\Spatial\Results”—for its value. Alternatively, click the browse button to the right of the Scratch Workspace text box and navigate to this location. The scratch workspace will be set by default as the path for outputs from running tools.

You’ll also set the extent for results from running Spatial Analyst tools to be the same as the elevation data, since this is the approximate boundary of your study area. All results generated will have the same extent as the elevation dataset.

10. Click the Extent drop-down arrow and click Same as Layer “elevation”.
11. Expand the Raster Analysis Settings section.
12. Your elevation dataset has the largest cell size (30 meters). Click the Cell Size drop-down arrow and click Same as Layer “elevation”. The cell size of your elevation layer will be applied to all subsequent raster outputs.

Note: Setting a smaller cell size than your largest input will not mean you have more detailed information in subsequent raster results; you will just have more cells of the same value, which may affect your display and

calculation speeds. Although the software does not prevent it, it is considered incorrect to set a cell size smaller than your largest input cell size.

13. Click OK on the Environment Settings dialog box.

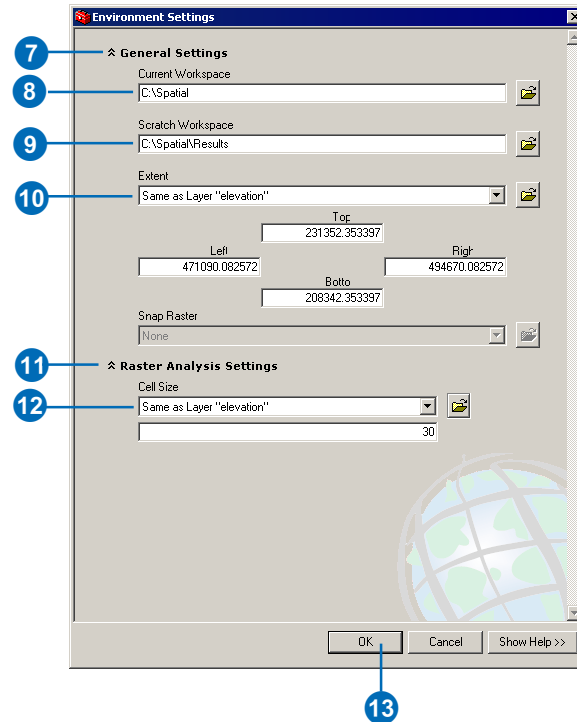

14. Click OK on the Model Properties dialog box.
15. Click the Model menu and click Save.

The model’s properties are updated. If at any point you want to close the model and carry on later, right-click the model in the ArcToolbox window and click Edit to continue with the tutorial.

Deriving datasets

In the previous exercise, you added the input datasets that you will use in the model to your ArcMap session. You've set up environment settings. You are ready to start to process your project data to locate suitable areas for the new school. You'll derive the following from your project data:

- Slope from elevation
- Distance from recreation sites
- Distance from existing schools

Deriving slope

Since the area is mountainous, you need to find areas of relatively flat land on which to build, so you will take into consideration the slope of the land.

1. If the Spatial Analyst Tools toolbox is not present in the ArcToolbox window, right-click the ArcToolbox window and click Add Toolbox. Click the Look in dropdown arrow and click Toolboxes. Double-click System Toolboxes, click Spatial Analyst Tools and click Open.
2. In the Spatial Analyst Tools toolbox, expand the Surface toolset.
3. Click and drag the Slope tool onto the ModelBuilder window.

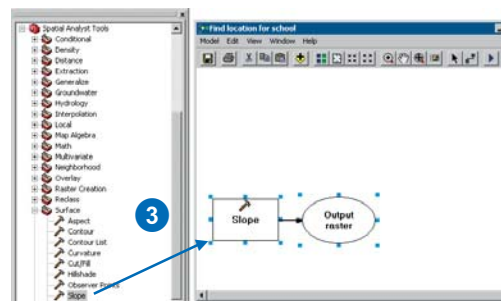

A Slope tool element and a connected derived data element are created in the display window.

4. Right-click the Slope tool element and click Open or double-click the Slope tool element.

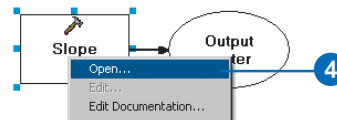

5. Click the Input raster drop-down arrow and click the elevation layer. Layers are denoted with a yellow icon in the drop-down list.
6. Accept the default path and name given for the Output raster parameter value. The default path is set to the scratch workspace you set earlier on the Environment Settings dialog box.
7. Leave the default for the Output measurement parameter to calculate slope in degrees.
8. As you did when calculating hillshade, type "0.3048" for the value of the Z factor parameter to convert the z-values to the same unit of measure as the x,y units (from feet to meters).
9. Click OK.

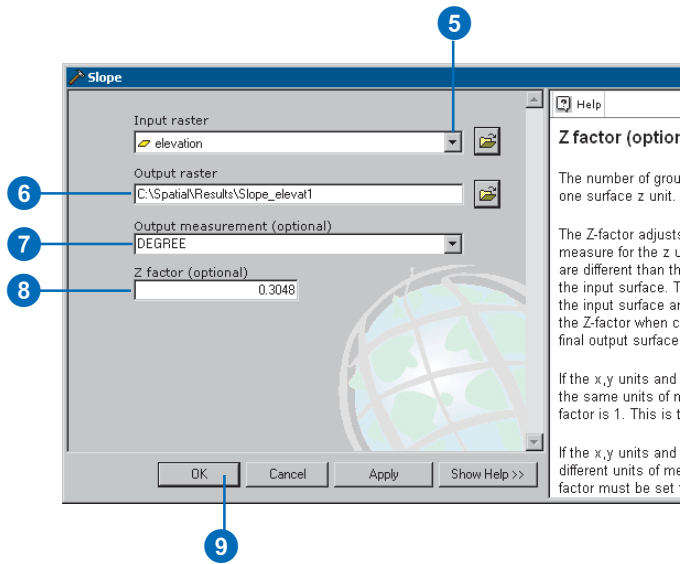

10. Click the Auto Layout button, then click the Full Extent button to apply the current diagram properties to the elements and place them within the display window.

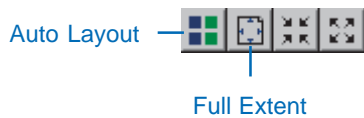

Notice that the process (consisting of the tool, project data, and derived data elements) is now filled with a solid color, meaning it is ready to run.

11. Right-click the derived data element for the Slope tool and click Rename.
12. Type “Slope output” and click OK.

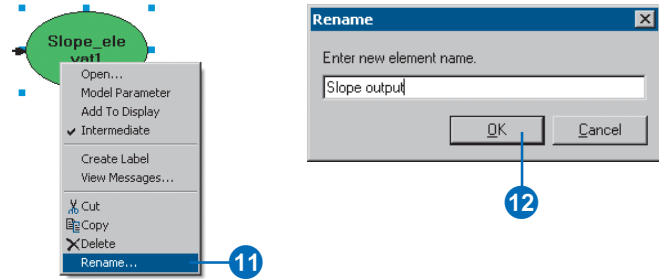

Note: Renaming an element label does not alter the name of the output on disk.

13. Right-click the Slope output data element again and click Add To Display.

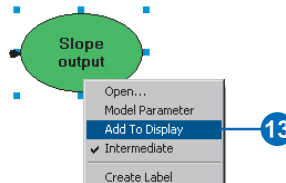

With the Add To Display property checked, the derived data referenced by this element will be added to the display each time the model is run from the ModelBuilder window.

14. Right-click the Slope tool element and click Run.

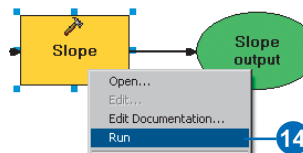

Notice that as the tool runs, its progress is documented on the progress dialog box, and the tool element that references the tool is highlighted in red. When the tool has finished running, the tool element and its derived data element become shaded, indicating that the derived data has been created on disk.

15. Check the Close this dialog when completed successfully check box if the Slope progress dialog box is present, then click Close.

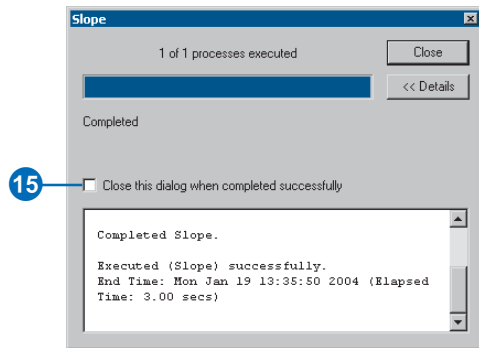

16. Examine the layer added to your ArcMap display. Steep slopes are displayed in red, less steep slopes in green in the output layer.

Deriving distance from recreation sites

To find locations close to recreation sites, you must first calculate the Euclidean (straight-line) distance from recreation sites.

1. In the Spatial Analyst Tools toolbox, expand the Distance toolset.
2. Click and drag the Euclidean Distance tool onto the ModelBuilder window.

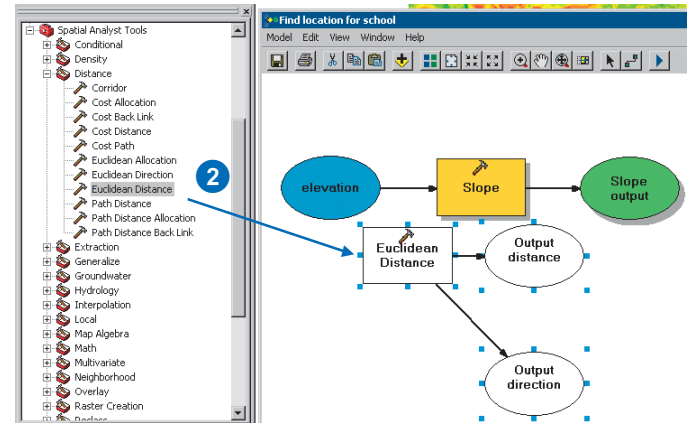

An element that references the Euclidean Distance tool is created on the display window.

3. Right-click the Euclidean Distance tool element and click Open.
 4. Click the Input raster or feature source data drop-down arrow and click the rec_sites layer.
 5. Accept the default path for the value of the Output distance raster parameter, but type “EucD_rsites” for the name.
- Instead of specifying a set distance from each point to use when calculating the output, you’ll accept the default for the Maximum distance parameter—the edge of the output raster is used as the maximum distance. The cell size is taken from the environment setting you set previously to be the same as your elevation data. In this exercise, the output direction raster is not required.
6. Click OK.

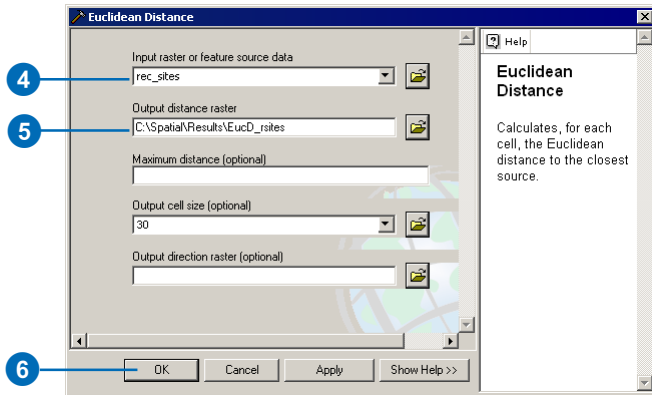

7. Click the Auto Layout button, then click the Full Extent button to apply the current diagram properties to the elements and place them on the display window.
8. Right-click the EucD_rsites derived data element for the Euclidean Distance tool and click Rename.
9. Type “Distance to recreation sites” in the Enter new element name text box and click OK on the Rename dialog box.
10. Right-click the Distance to recreation sites derived data element and click Add To Display.

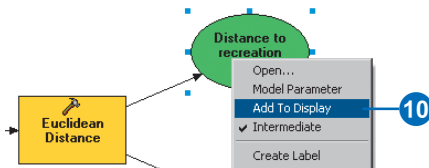

11. Right-click the Euclidean Distance tool element and click Run to run the process.

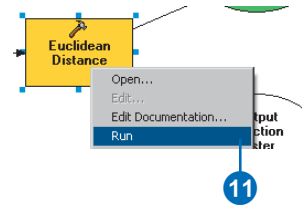

12. Examine the layer added to your ArcMap display.
Distances increase the farther you are from a recreation site.

Deriving distance from schools

To find locations away from existing schools, you must first calculate the Euclidean (straight-line) distance from schools.

1. Click and drag the Euclidean Distance tool from the Distance toolset onto the ModelBuilder window.

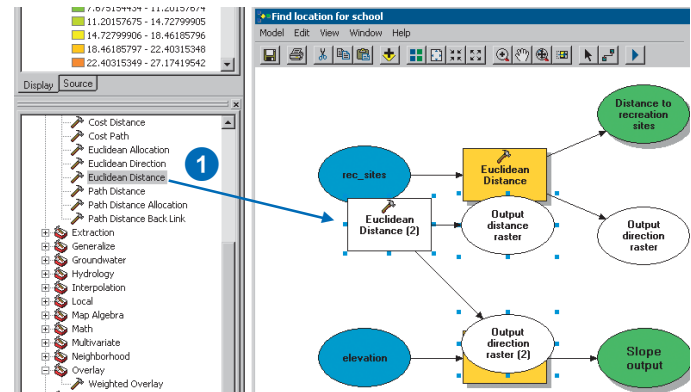

An element that references the Euclidean Distance tool is created on the display window.

2. Right-click the Euclidean Distance (2) tool element and click Open.
3. Click the Input raster or feature source data drop-down arrow and click the schools layer.
4. Accept the default path for the value of the Output distance raster parameter, but type “EucD_sch” for the name.

As with the distance to rec_sites output, instead of specifying a set distance from each point to use when calculating the output, you’ll accept the default for the Maximum distance parameter—the edge of the extent specified in the Environment Settings dialog box is used to set the maximum distance. The cell size is taken from the environment setting that you set previously to be the same as your elevation data. In this exercise, the output direction raster is not required.

5. Click OK.

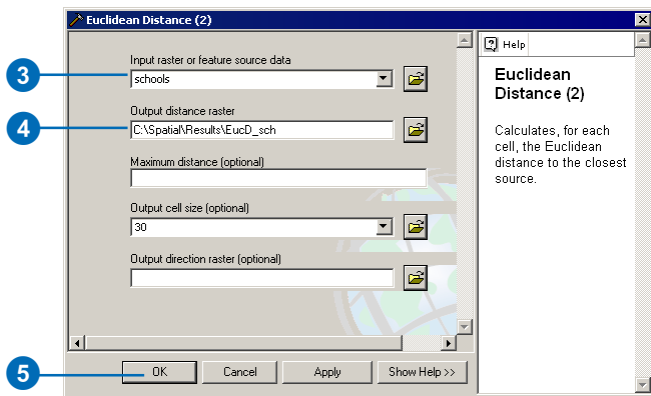

6. Click the Auto Layout button, then click the Full Extent button to apply the current diagram properties to the elements and place them on the display window.
7. Right-click the derived Parameter data element for the Euclidean Distance tool and click Rename.
8. Type “Distance to schools” and click OK.
9. Right-click the Distance to schools derived data element and click Add To Display.

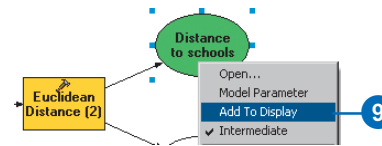

10. Right-click the Euclidean Distance (2) tool element and click Run to run the process.

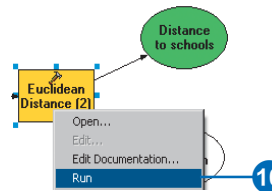

11. Examine the layer added to your ArcMap display.
Distances increase the farther you are from a school.

Reclassifying datasets

Deriving datasets, such as slope or distance to schools, is the first step when building a suitability model. Each cell in your study area now has a value for each input criteria (slope, landuse, distance to recreation sites and distance to schools). You need to combine the derived datasets so you can create your suitability map that will identify the potential locations for the new school. However it is not possible to combine them in their present form—for example, combining a cell value in which slope equals 15 degrees with a cell value for landuse that equals 7 (forest)—and get a meaningful answer that you can compare to other locations. To combine the datasets, they first need to be set to a common measurement scale, such as 1 to 10. That common measurement scale is what determines how suitable a particular location—each cell—is for building a new school. Higher values indicate more suitable locations for the school.

Using the Weighted Overlay tool, you can weight the values of each dataset, then combine them at one time. However, the inputs for the Weighted Overlay tool must contain discrete, integer values. Landuse is already categorized into discrete values; for example, forest equals a value of 7, so you can simply add this dataset directly into the Weighted Overlay tool and assign each cell a new value on the common measurement scale of 1 to 10 (you'll do this later in the tutorial). The values in the datasets you derived in previous steps are all floating point, continuous datasets, categorized into ranges, and they must first be reclassified so that each range of values is assigned one discrete, integer value. Potentially, the value given to each range can be any number, provided you note the range that the value corresponds to. This is because you can weight these values within the Weighted Overlay tool—the next step after reclassifying the derived datasets. However, it is

easier to weight the cell values for derived datasets while reclassifying. In the Weighted Overlay tool, you can accept the default and leave the scale values the same as the input values.

You will reclassify each derived dataset to a common measurement scale, giving each range a discrete, integer value between 1 and 10. Higher values will be given to attributes within each dataset that are more suitable for locating the school.

Reclassifying slope

It is preferable that the new school site be located on relatively flat ground. You'll reclassify the slope output, slicing the values into equal intervals. You'll assign a value of 10 to the most suitable range of slopes (those with the lowest angle of slope), 1 to the least suitable range of slopes (those with the steepest angle of slope), and rank the values in between linearly.

1. In the Spatial Analyst Tools toolbox, expand the Reclass toolset.
2. Click and drag the Reclassify tool onto the ModelBuilder window.

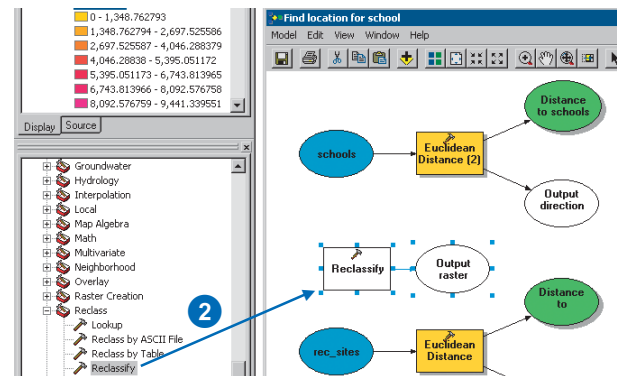

A Reclassify tool element and a connected derived data element are created in the display window.

- Right-click the Reclassify tool element and click Open.

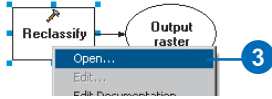

- Click the Input raster drop-down arrow and click the variable Slope output. Variables are denoted with blue icons in the drop-down list. When you drag data onto a ModelBuilder window or set the data referenced by input or derived data elements within a tool's dialog box, the elements created on the ModelBuilder window are variables that can be shared between processes.
- Accept the default for the Reclass field parameter so the Value field will be used.
- Click Classify.

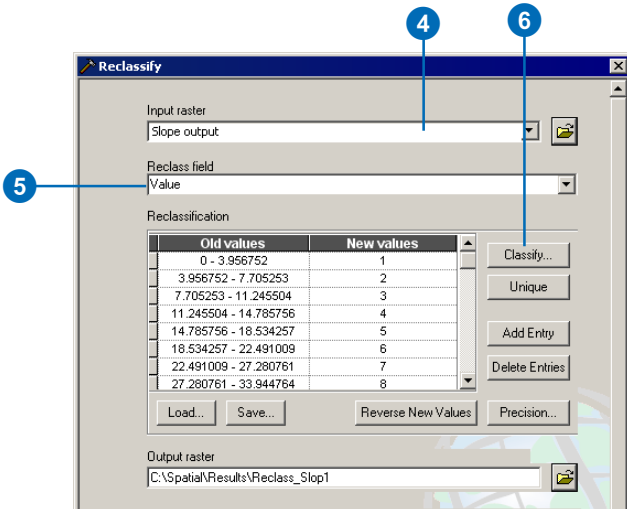

- Click the Method drop-down arrow and click Equal Interval.
- Click the Classes drop-down arrow and click 10.
- Click OK.

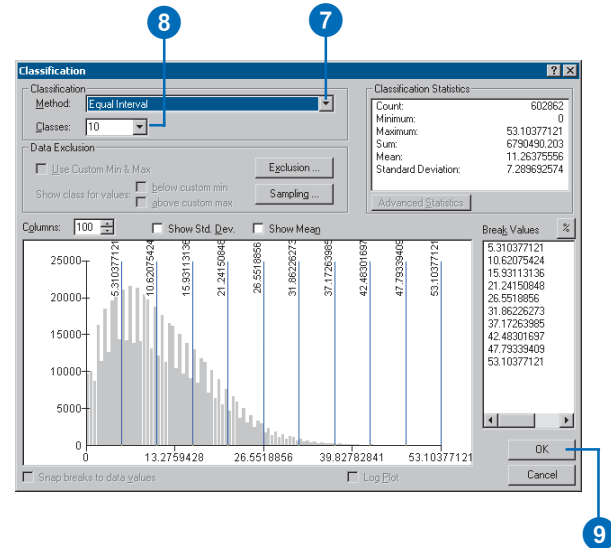

You want to reclassify the slope layer so steep slopes are assigned low values, since these are least suitable for building.

10. Click Reverse New Values so that ranges of values representing less steep slopes receive a higher new value, since these areas are more suitable for building.
11. Accept the default path for the value of the Output raster parameter, but type “Rslope” for the name.
12. Click OK.

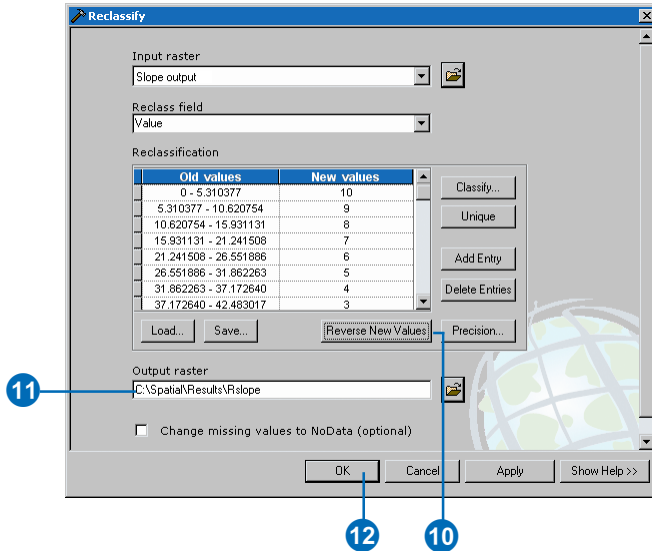

13. Click the Auto Layout button, then click the Full Extent button to apply the current diagram properties to the elements and place them within the display window.
14. Right-click the derived data element for the Reclassify tool and click Rename.

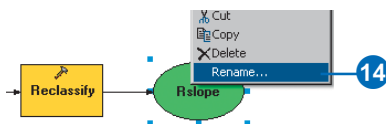

15. Type “Reclassified slope” in the Enter new element name text box and click OK.
16. Right-click the Reclassified slope derived data element and click Add To Display.

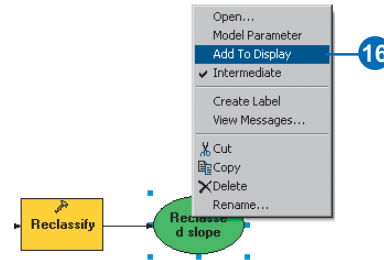

17. Right-click the Reclassify tool element and click Run to run the process.

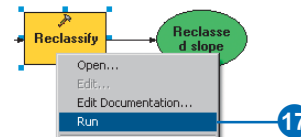

18. Examine the layer added to your ArcMap display. Locations with higher values (less steep slopes) are more suitable than locations with lower values (steeper slopes).

Reclassifying distance to recreation sites

The school should be located as close as possible to a recreational facility. You will reclassify the distance to recreation sites output, assigning the number 10 to ranges of values that represent areas closest to recreation sites (the most suitable locations), assigning the number 1 to ranges of values that represent areas far from recreation sites (the least suitable locations), and ranking the values linearly in between.

1. Click and drag the Reclassify tool from the Reclass toolset onto the ModelBuilder window.

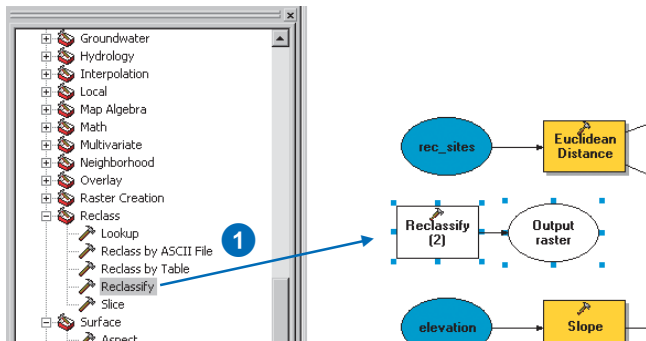

2. Right-click the Reclassify (2) tool element and click Open.
3. To connect the output from the Euclidean Distance tool as input for the Reclassify (2) tool, click the Input raster drop-down arrow and click the variable Distance to recreation sites.
4. Accept the default for the Reclass field parameter so the Value field will be used.

5. Click Classify.

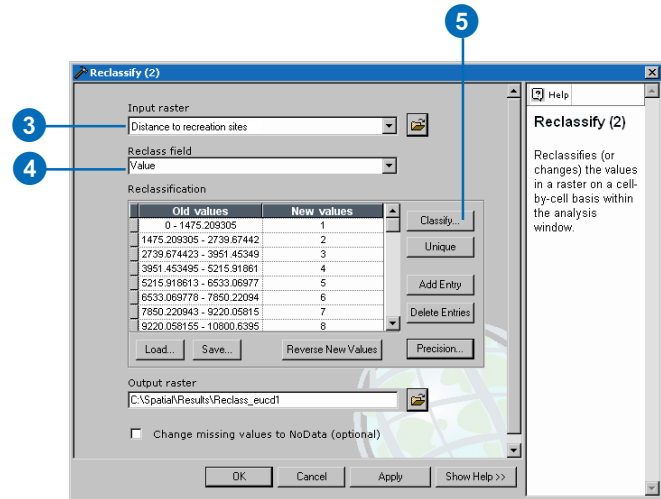

6. Click the Method drop-down arrow and click Equal Interval.
7. Click the Classes drop-down arrow and click 10.
8. Click OK.

You want the school to be close to a recreational facility, so you will assign a larger number to ranges of values that represent locations close to recreational facilities, since distances that are close are most desirable.

9. Click Reverse New Values so that distances close to recreational facilities receive a higher new value, since these areas are more desirable.
10. Accept the default path for the value of the Output raster parameter, but change the default name to “Rdist_rec”.
11. Click OK.

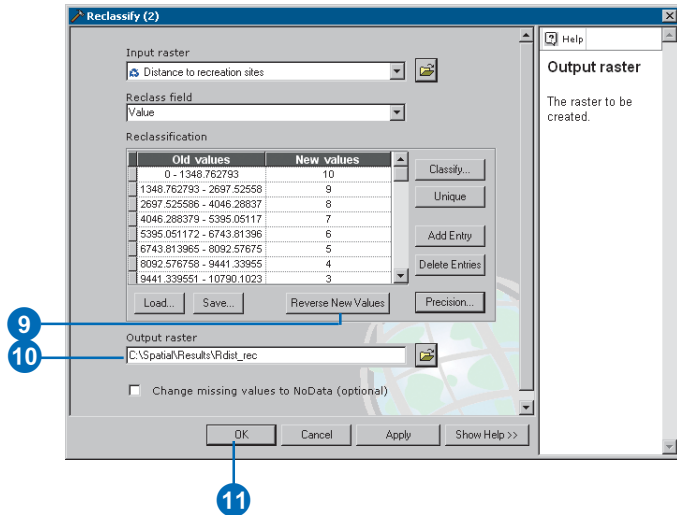

12. Click the Auto Layout button, then click the Full Extent button to apply the current diagram properties to the elements and place them within the display window.
13. Right-click the derived data element for the Reclassify (2) tool and click Rename.

14. Type “Reclassed distance to recreation sites” and click OK.
15. Click the Reclassed distance to recreation sites derived data element, move the mouse pointer over one of the blue handles surrounding the element, then click and drag to resize the element so all text can be seen.
16. Right-click the Reclassed distance to recreation sites derived data element and click Add To Display.
17. Right-click the Reclassify (2) tool element and click Run to run the process.

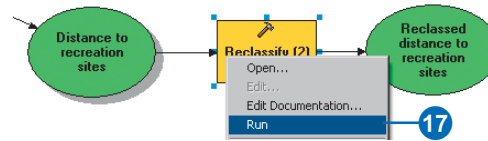

18. Examine the layer added to your ArcMap display. Locations with higher values—areas close to recreation sites—are more suitable than locations with lower values—areas far from recreation sites.

Reclassifying distance to schools

It is necessary to locate the new school away from existing schools to avoid encroaching on their catchment areas. You will reclassify the Distance to schools layer, assigning a value of 10 to areas farthest from existing schools (the most suitable locations), assigning a value of 1 to areas near existing schools (the least suitable locations), and ranking the values in between linearly. By doing this, you will determine which areas are near and which areas are far from existing schools.

1. Click and drag the Reclassify tool from the Reclass toolset onto the ModelBuilder window.

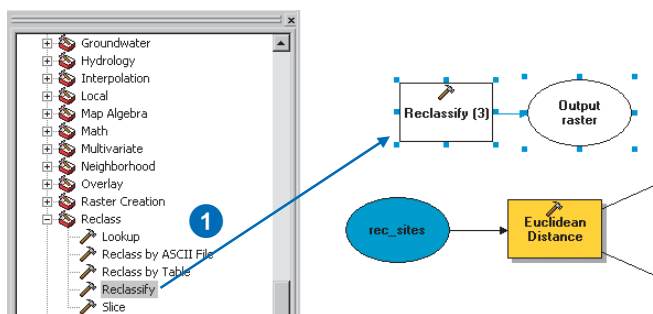

An element that references the Reclassify tool is created in the display window.

2. Right-click the Reclassify (3) tool element and click Open.
3. Click the Input raster drop-down arrow and click the Distance to schools variable.
4. Accept the default for the Reclass field parameter so the Value field will be used.
5. Click Classify.

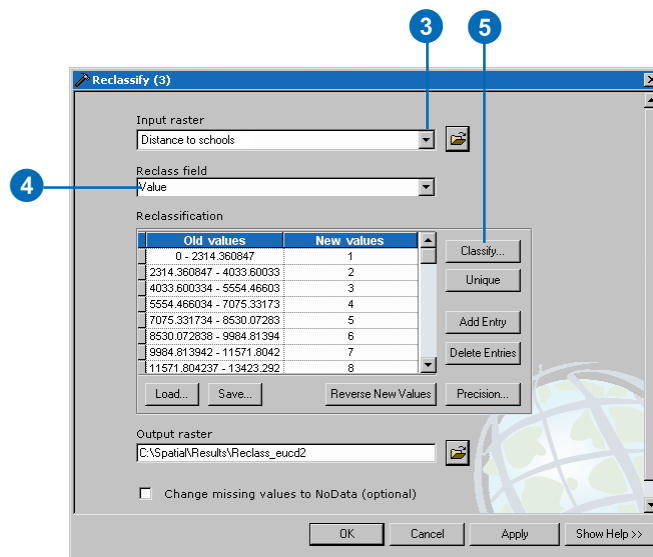

6. Click the Method drop-down arrow and click Equal Interval.
7. Click the Classes drop-down arrow and click 10.
8. Click OK.

You want to position the school away from existing schools, so you will assign larger numbers to ranges of values that represent locations farther away, because these locations are most desirable. Since the default assigns high New values (more suitable locations) to higher ranges of Old values (locations farther away from existing schools), you do not need to change any values at this time.

9. Accept the default path for the value of the Output raster parameter, but type “Rdist_sch” for the name.
10. Click OK.

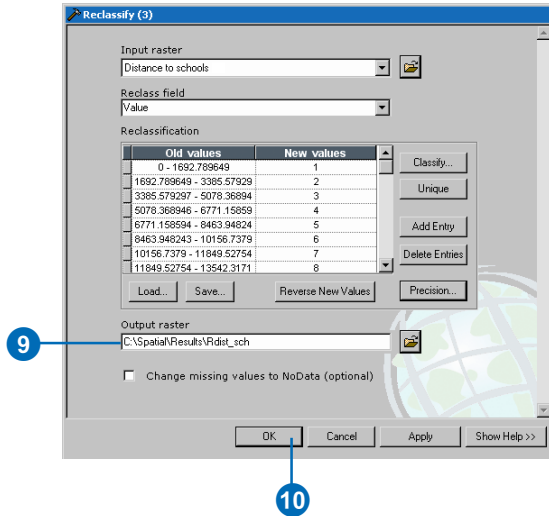

11. Click the Auto Layout button, then click the Full Extent button to apply the current diagram properties to the elements and place them within the display window.
12. Right-click the derived data element for the Reclassify (3) tool and click Rename.
13. Type “Reclassified distance to schools” and click OK.
14. Right-click the Reclassified distance to schools derived data element and click Add To Display.
15. Right-click the Reclassify (3) tool element and click Run to run the process.

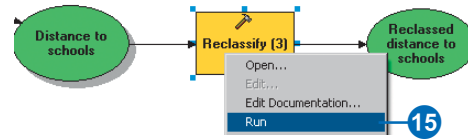

16. Examine the layer added to your ArcMap display. Locations with higher values (areas away from existing schools) are more suitable than locations with lower values (areas close to existing schools).
17. Click the Model menu and click Save.

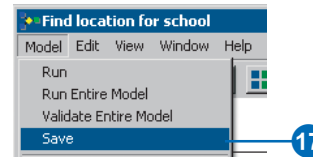

Weighting and combining datasets

You are now ready to combine the derived datasets and landuse to find the most suitable locations. The values of the derived datasets representing slope, distance to recreation sites, and distance to schools have all been reclassified to a common measurement scale (more suitable cells have higher values). The landuse dataset is still in its original form because you can weight the cell values for this dataset as part of the weighted overlay process. Values representing areas of water and wetlands will be restricted. You'll also mark slope values that are less than 4 (the least suitable because they are too steep) as restricted so these values can be excluded. You'll learn more about restricted values and NoData later in this exercise. If all datasets were equally important, you could simply combine them, giving each equal influence; however, you have been

informed that it is preferable to locate the new school close to recreational facilities and away from other schools. You will weight all the inputs, assigning each a percentage of influence. The higher the percentage, the more influence a particular input will have in the suitability model.

You will assign the inputs the following percentages of influence:

Reclassified distance to rec_sites:	50%
Reclassified distance to schools:	25%
Reclassified slope:	13%
Landuse:	12%

1. In the Spatial Analyst Tools toolbox, expand the Overlay toolset.
2. Click and drag the Weighted Overlay tool onto the ModelBuilder window.

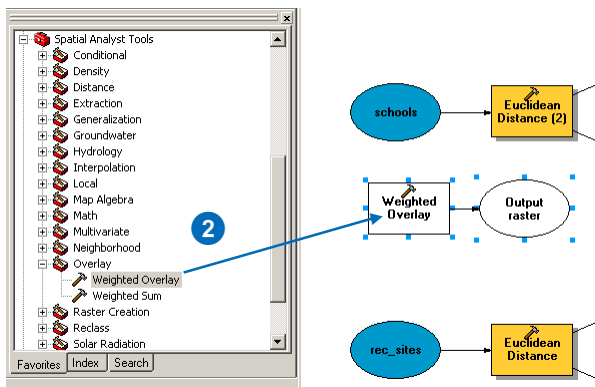

An element that references the Weighted Overlay tool is created in the display window.

3. Right-click the Weighted Overlay tool element and click Open.

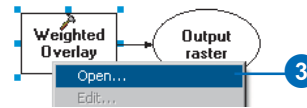

The default evaluation scale is from 1 to 9 by 1. A scale of 1 to 10 was used when reclassifying datasets, so before adding input rasters to the Weighted Overlay tool, you want to set the evaluation scale from 1 to 10 by 1. This means you will avoid having to update the scale values after adding your input datasets.

4. Type “1”, “10”, and “1” in the From, To, and By text boxes.
5. Click the Add raster row button to add the input rasters.

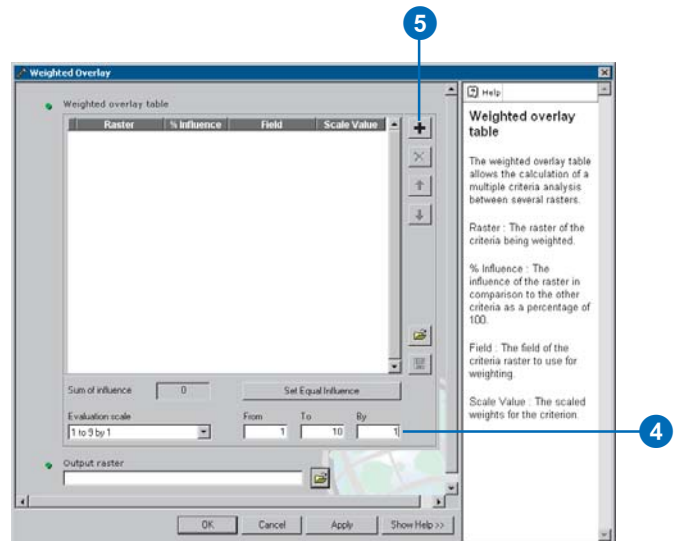

6. Click the Input raster drop-down arrow and click the Reclassed distance to schools variable.
7. Accept the default Input field and click OK.

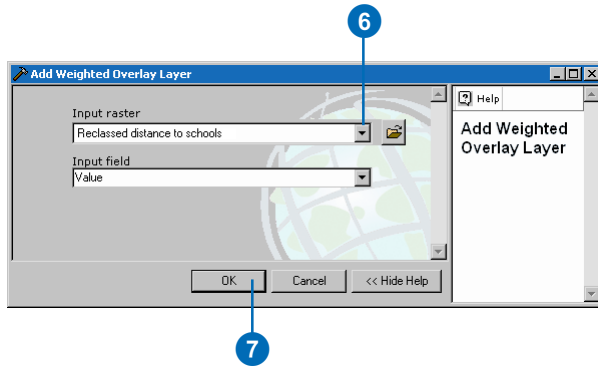

The raster is added to the Weighted Overlay tool. The Field column displays the values of the Reclassed distance to schools output. The Scale Value column mimics the Field column because the evaluation scale was set to encompass the range of values in each input raster. You could modify the scale values for each class at this point, but for this input, the values were already weighted appropriately at the time of reclassifying.

8. Click the Add Raster Row button again to add the next input raster.
9. Click the Input raster drop-down arrow and click the Reclassed distance to recreation sites variable.
10. Accept the default value for the Input field parameter and click OK.

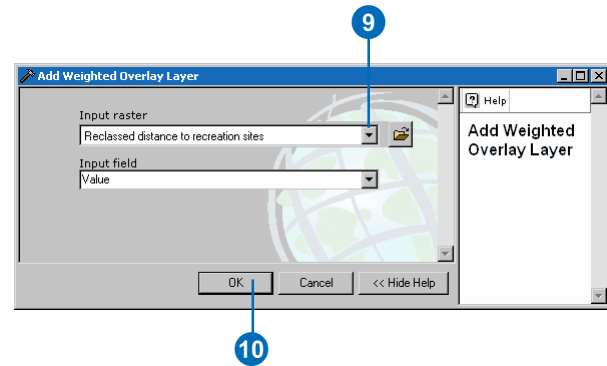

The raster is added to the Weighted Overlay tool. The Field column displays the values of the Reclassed distance to recreation sites output. As with the Reclassed distance to schools input, the Scale Value column mimics the Field column because the evaluation scale was set to encompass the range of values in each input raster. You could modify the scale values for each class at this point, but for this input, the values were already weighted appropriately at the time of reclassifying.

11. Click the Add raster row button again to add the next input raster.

12. Click the Input raster drop-down arrow and click the Reclassed slope variable.
13. Accept the default value for the Input field parameter and click OK.

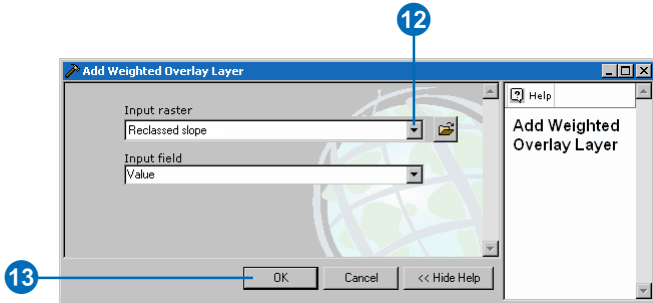

The raster is added to the Weighted Overlay tool.

14. Scroll down to the Reclassed slope input.

For this input, the values were already weighted appropriately at the time of reclassifying. However, you know you don't want to build on slopes greater than about 35 percent, even if all other conditions are ideal. You'll make values from 1 to 3 restricted—since these values represent slopes from 37.17263985 to 53.1037712 (the maximum slope).

Setting a scale value to restricted assigns a value to that cell in the output weighted overlay result that is the minimum value of the evaluation scale set minus 1 (zero in this exercise). If there are no inputs to the Weighted Overlay tool with cells of NoData, you could use NoData as the scale value to exclude certain values. However, if you have NoData cells in any of your inputs, it is safest to use Restricted. Potentially, a result from the Weighted Overlay tool could contain cells of NoData that have come from one or more of the inputs (NoData on any input equals NoData

in the result) and restricted areas that you intentionally excluded. NoData and Restricted values should not be confused. Each serves a specific purpose. There may be areas of NoData where you don't know the value but that are actually suitable areas. If you use NoData to exclude certain cell values and there is NoData in one or more inputs, you will not know whether a cell of NoData means the area is restricted from use or there was no input data available in that location.

15. In the Scale Value column for the Reclassed slope raster, click the cell with a value of 1.
16. Click the drop-down arrow, scroll and click Restricted.
17. Follow this procedure for scale values of 2 and 3.
18. Click the Add raster row button again to add the last input raster.

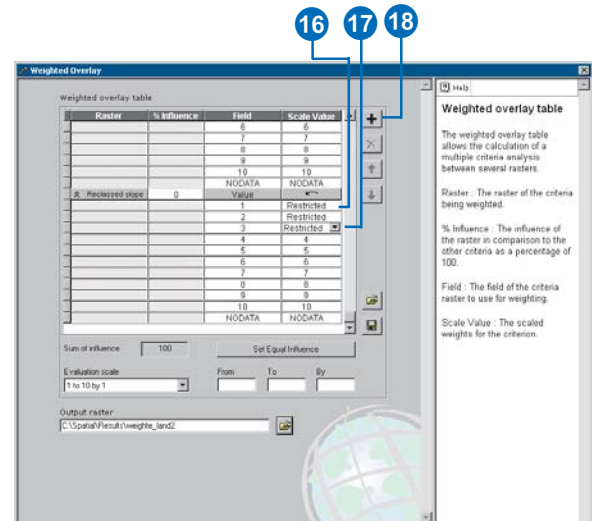

19. Click the Input raster drop-down arrow and click the landuse layer.
20. Click the Input field drop-down arrow and click Landuse.
21. Click OK.

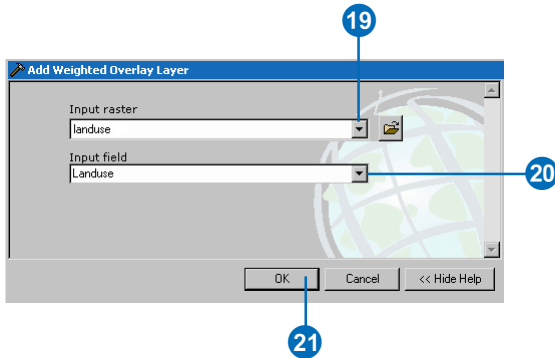

All input rasters are now added to the Weighted Overlay dialog box.

22. Scroll down to the landuse input.

You'll now weight the scale values of the landuse layer so they are comparable with the other inputs. A lower value indicates that a particular landuse type is less suitable for building. The scale values for Water and Wetlands will be set as Restricted, since they cannot be built on and should be excluded.

23. Change the default scale values for the landuse layer to the following values:

- Brush/transitional—5
- Barren land—10
- Built up—3
- Agriculture—9
- Forest—4

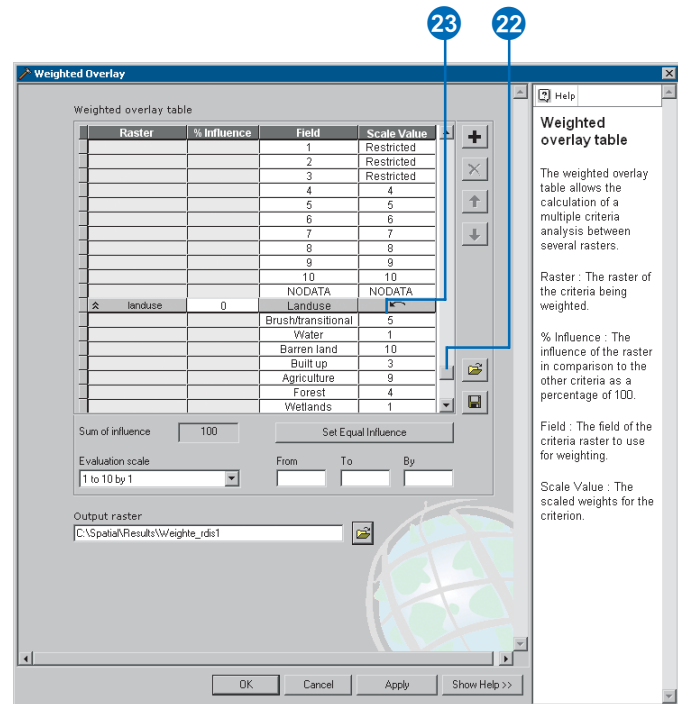

You'll now set the scale values representing Water and Wetlands to Restricted.

24. In the Scale Value column, click the cell next to the landuse type Water.

25. Click the drop-down arrow and click Restricted.

26. In the Scale Value column, click the cell next to the landuse type Wetlands.

27. Click the drop-down arrow and click Restricted.

landuse	0	Landuse	
		Brush/transitional	5
		Water	Restricted
		Barren land	10
		Built up	3
		Agriculture	9
		Forest	4
		Wetlands	Restricted
		NODATA	NODATA

28. Collapse each raster in the Weighted overlay table.

28

Raster	% Influence	Field	Scale Value
Reclassified distanc	100	Value	
Hide rows: Reclassed distance to schools			
		1	1
		2	2
		3	3
		4	4
		5	5
		6	6
		7	7
		8	8
		9	9
		10	10
		NODATA	NODATA
Reclassified distanc	0	Value	
Reclassified slope	0	Value	
landuse	0	Landuse	

You'll now assign a percentage of influence to each raster, based on how much importance (or weight) each should have in the final suitability map.

29. In the % Influence column, type the following percentages for each of the input rasters:

Reclassified distance to schools	25
Reclassified distance to recreation sites	50
Reclassified slope	13
landuse	12

Note: Move the mouse pointer over the name of an input raster to view the entire name.

30. Accept the default path for the Output raster parameter value, but type "suit_areas" for the name.

31. Click OK.

29

30

31

32. Click the Auto Layout button, then click the Full Extent button to apply the current diagram properties to the elements and place them within the display window.
33. Right-click the derived data element for the Weighted Overlay tool and click Rename.

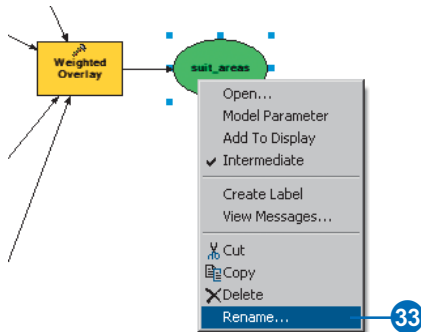

34. Type “Suitable Areas” and click OK.

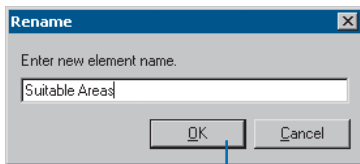

35. Right-click the Suitable Areas derived data element and click Add To Display.

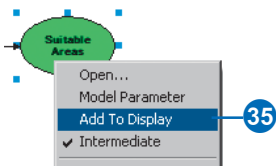

36. Right-click the Weighted Overlay tool element and click Run to run the process.

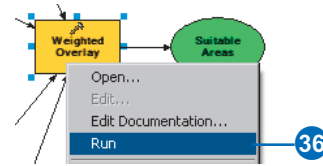

37. Examine the layer added to your ArcMap display. Locations with higher values indicate more suitable sites—areas that are on less steep slopes of suitable land-use types, closer to recreational facilities, and away from existing schools. Notice that the areas you marked as restricted have a value of zero.

Selecting optimal sites

You’ll use a conditional expression in the Con tool to extract only the optimal sites. It has been decided that those sites that are considered optimal must have a suitability value of 9 (the highest value in the `suit_areas` output). In the conditional expression, all areas with a value of 9 will retain their original value (9). Areas with a value of less than 9 will be changed to NoData.

1. In the Spatial Analyst Tools toolbox, expand the Conditional toolset.
2. Click the Con tool and drag it onto the ModelBuilder window.

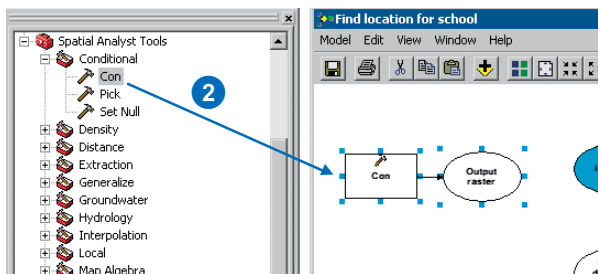

An element that references the Con tool is created in the display window.

3. Right-click the Con tool element and click Open.

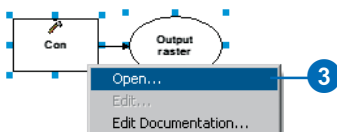

4. Click the Input conditional raster drop-down arrow and click the Suitable Areas variable.
5. Click the Input true raster or constant value drop-down arrow and click the Suitable Areas variable.

If the condition you enter is true of the cells in the Input conditional raster, the value of the cells of the Input true raster or constant value will be applied to the cells of the output raster.

6. Leave the value for the Input false raster or constant value parameter blank. The default will be applied—any value in the Input conditional raster that doesn't meet

the condition you enter will be assigned NoData in the output raster.

7. Accept the default path for the Output raster parameter value, but change the default name to "opt_areas".
8. Type the condition "Value = 9" for the value of the Expression parameter.
9. Click OK.

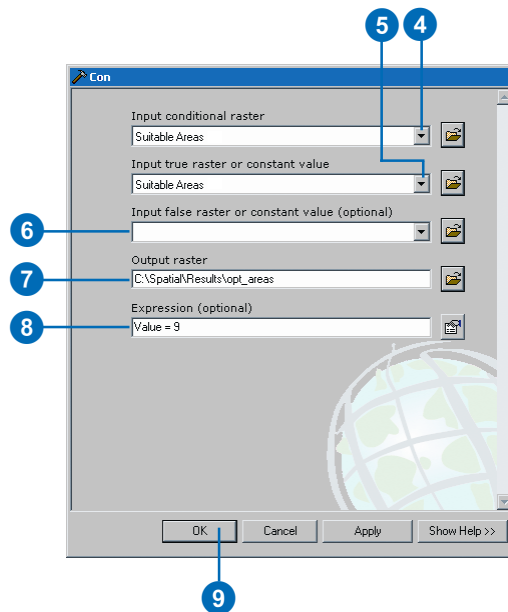

- Click the Auto Layout button, then click the Full Extent button to apply the current diagram properties to the elements and place them within the display window.
- Right-click the derived data element for the Con tool and click Rename.

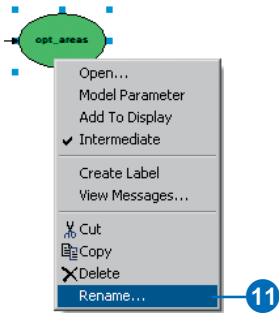

- Type “Output optimal areas raster” in the Enter new element name text box and click OK on the Rename dialog box.
- Right-click the Output optimal areas raster derived data element and click Add To Display.

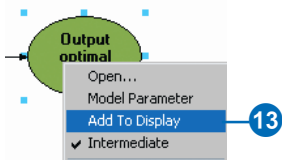

- Right-click the Con tool element and click Run to run the process.

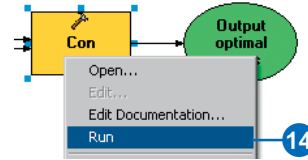

- Examine the layer added to your ArcMap display. These are the optimal site locations for the new school. There are many single cells representing optimal locations. These 30-meter cells are too small for the school site. You’ll clean up the result, removing these small areas, using the Majority Filter tool.
- In the Spatial Analyst Tools toolbox, expand the Generalization toolset.
- Click the Majority Filter tool and drag it into the ModelBuilder window.

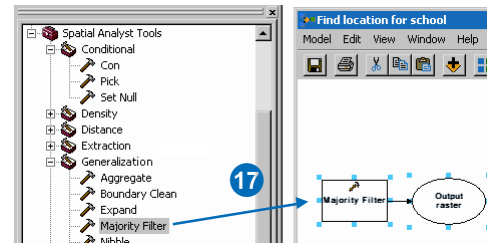

An element that references the Majority Filter tool is created in the display window.

- Right-click the Majority Filter tool element and click Open.

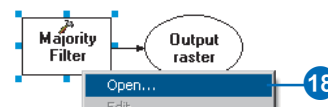

19. Click the Input raster drop-down arrow and click the Output optimal areas raster variable.
20. Accept the default path for the value of the Output raster parameter, but change the name for the output raster to “opt_areasM”.
21. Click the Number of neighbors to use drop-down arrow and click EIGHT.

This option specifies the number of neighboring cells to use in the kernel of the filter. The kernel of the filter will be the eight nearest neighbors (a 3-by-3 cell window) to the present cell.

22. Accept the default to use the MAJORITY as the replacement threshold. Five out of eight connected cells must have the same value for the present cell to retain its value.
23. Click OK.

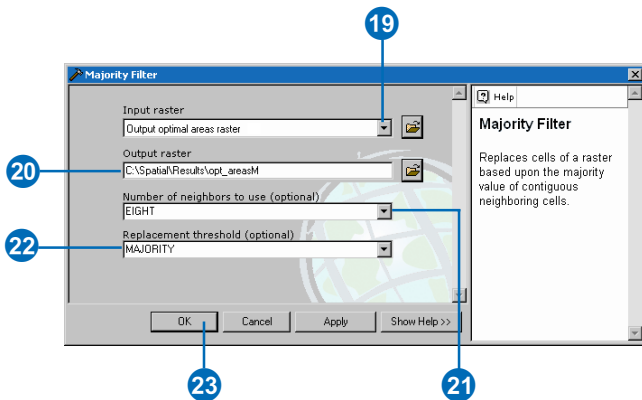

24. Click the Auto Layout button, then click the Full Extent button to apply the current diagram properties to the elements and place them within the display window.

25. Right-click the derived data element for the Majority Filter tool and click Rename.
26. Type “Output filtered optimal areas raster” and click OK.

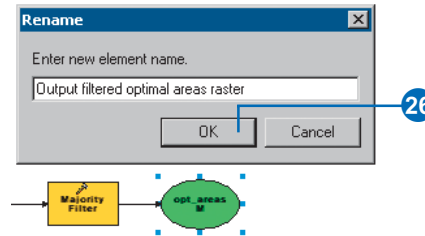

27. Right-click the Output filtered optimal areas raster derived data element and click Add To Display.

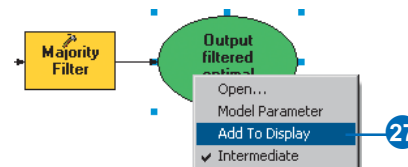

28. Right-click the Majority Filter tool element and click Run to run the process.
29. Examine the layer added to your ArcMap display. Compare it to the layer opt_areas. Many optimal areas that were considered too small in area have been removed.

Note: If you want to remove areas of multiple cells, use the Nibble tool.

Setting model parameters

After completing your model, you can set variables as model parameters so they will display on the dialog box of your model. If you plan to distribute your model, you should set model parameters so the users of your model can specify the input parameters. In the case of this suitability model, it could be applied to a different area, using different input data, for instance.

First, you'll rename the input data variables and the final output variable, since these names will become the parameter labels on the model's dialog box.

1. Right-click the landuse project data element and click Rename.
2. Type "Input landuse raster" and click OK.
3. Right-click the elevation project data element and click Rename.
4. Type "Input elevation raster" and click OK.
5. Right-click the rec_sites project data element and click Rename.
6. Type "Input recreation sites feature class" and click OK.
7. Right-click the schools project data element and click Rename.
8. Type "Input schools feature class" and click OK.
9. Right-click each of Input landuse raster, Input elevation raster, Input schools feature class, and Input recreation sites feature class and click Model Parameter.

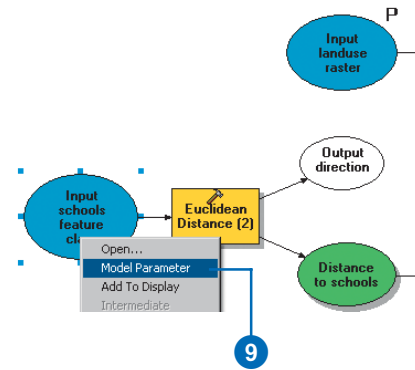

10. Right-click the Output filtered optimal areas raster derived data element and click Model Parameter.
11. Click the Model menu and click Save, then click the Model menu again and click Close.

Viewing the model's dialog box

1. Right-click the Find location for school model in the ArcToolbox window and click Open.

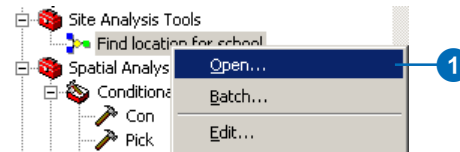

The variables you made into model parameters are displayed as the parameters on the model's dialog box. Users of your model can simply enter their own parameter values to find suitable locations for a school in their area without having to know much information about the underlying workings of the model. They would, of course, have to have the same fields present in the landuse data, understand the methodology of the model, and agree with the assumptions applied. This information can be documented with the tool.

Note: An `opt_areasM` dataset already exists. This output cannot be overwritten by default. To change the default behavior so results can be overwritten, click Tools on the Main Menu and click Options. Click the Geoprocessing tab and check Overwrite the outputs of geoprocessing operations.

2. Click Cancel on the model's dialog box.

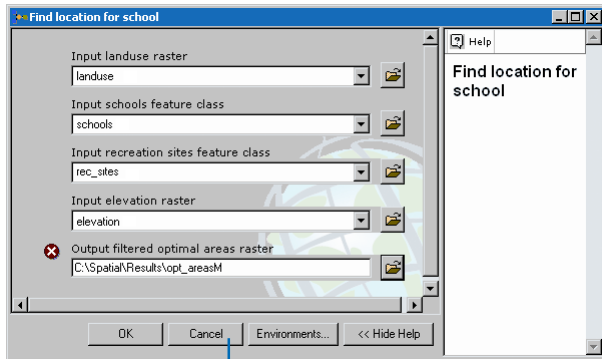

The Documentation Editor can be used to add documentation to your tools.

3. Right-click the model and click Edit Documentation.

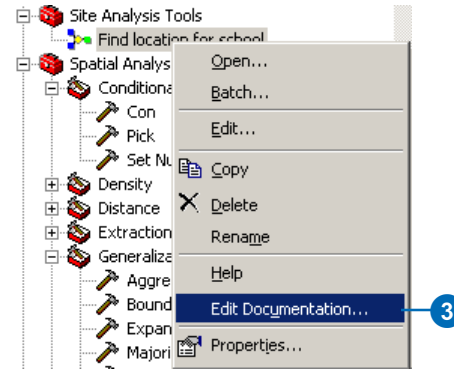

For more information on documenting your tools, type “documentation” in the index of the ArcGIS Desktop Help system.

4. Click Cancel on the Documentation Editor.

Selecting the best site

You've discovered the optimal sites for building the new school. All the locations in the `opt_areasM` layer are suitable. The last step in this exercise is to locate the best site out of the alternatives. The roads layer displays the roads within the town of Stowe. By examining the `opt_areasM` layer with the roads layer, you'll see that there are some suitable areas for the school site that are not close to roads within the town. You'll first exclude these areas by locating suitable sites that are intersected by roads. Then you'll locate the best site based on area. An optimal school site is larger than 10 acres, or 40,469 square meters.

You'll first convert the `opt_areasM` raster to a feature class inside a geodatabase so you can use the area field that is generated. You'll use the selection functionality within ArcMap to select features that are intersected by roads. Then you'll identify the optimal site from the alternatives,

based on area, and you'll create a new feature class from the selection that you'll use in the next exercise.

1. In the Conversion Tools toolbox, expand the From Raster toolset.
2. Right-click the Raster to Polygon tool and click Open.

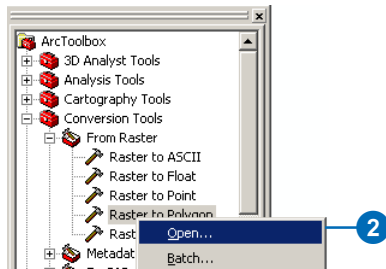

3. Click the Input raster drop-down arrow and click the Output filtered optimal areas raster layer.
4. Leave the default for the Field parameter as VALUE.
5. Click the Output polygon features browse button, navigate to your C:\Spatial\Results folder, then double-click Site.gdb (the file geodatabase you created in the previous exercise).
6. Type "opt_areasM" for the name of the feature class to create inside the geodatabase, then click Save.
7. Leave the default checked to Simplify polygons. The polygons will be simplified to reduce the "stair-step" effect when a raster is converted to a polygon.
8. Click OK.

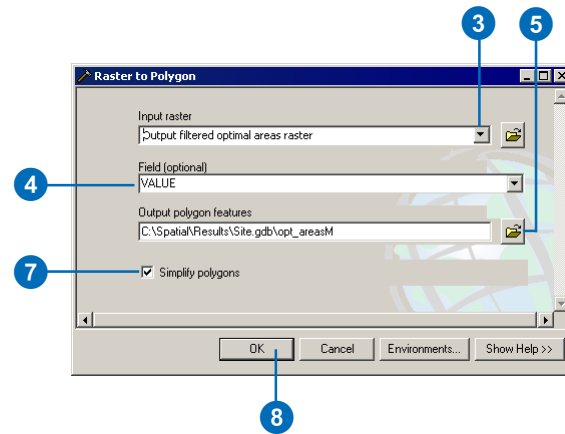

9. Leave the landuse, elevation, hillshd, destination, roads, rec_sites, schools, and opt_areasM (feature class) layers in the table of contents. Click the rest of the generated layers in the table of contents, right-click, then click Remove. Press and hold the Shift key to select multiple layers. Your ArcMap table of contents and display should resemble the graphic below.

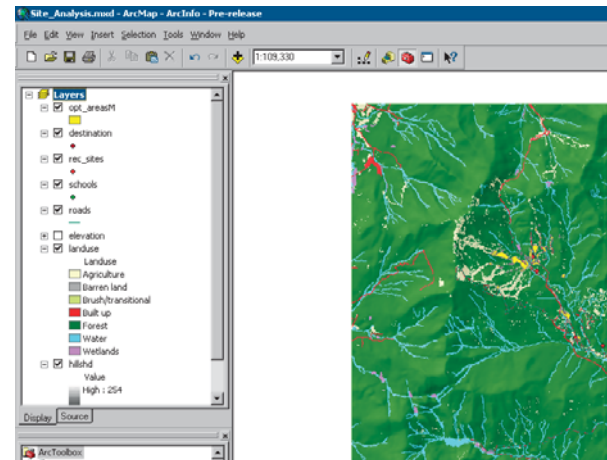

10. Click Selection on the Main Menu and click Select By Location.

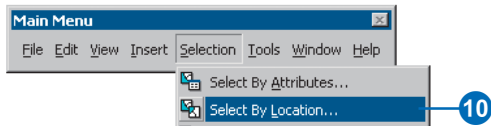

11. Set up the dialog box as shown below. You want to select features from opt_areasM that intersect roads.

12. Click Apply, then click Close.

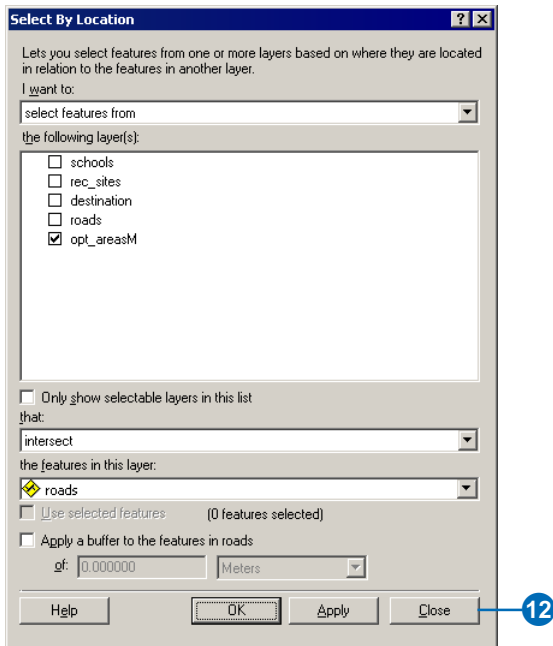

All features that intersect roads are selected in the display.

13. Click Selection on the Main Menu again and click Select By Attributes.

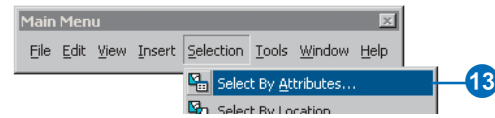

14. Click the Layer drop-down arrow and click the layer opt_areasM.

15. Click the Method drop-down arrow and click Select from current selection.

16. Double-click [Shape_Area] in the list of fields to enter the field into the expression text box.

17. Click the > = button.

18. Type a space, then type "40469".

19. Click Apply, then click Close.

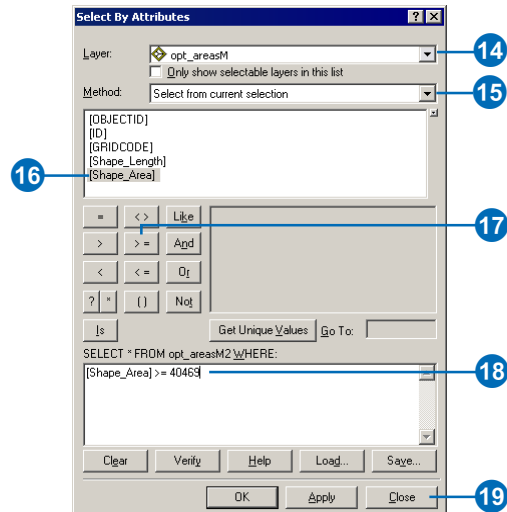

There is one feature that fits the criteria of being equal to or greater than 10 acres (40,469 square meters).

20. Right-click `opt_areasM` in the table of contents, point to Selection, then click Create Layer From Selected Features.

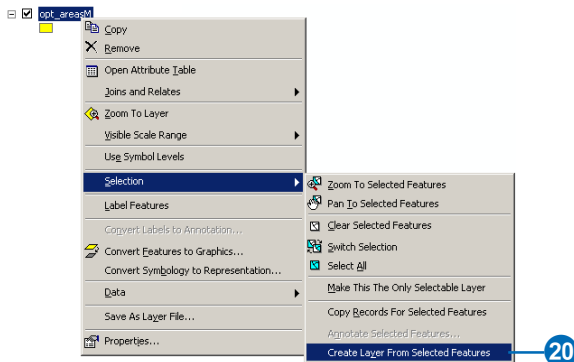

The added layer `opt_areasM selection` is an in-memory layer that references the `opt_areasM` feature class. You'll save it as a feature class on disk.

21. In the Data Management Tools toolbox, expand the Features toolset.
22. Right-click the Copy Features tool and click Open.

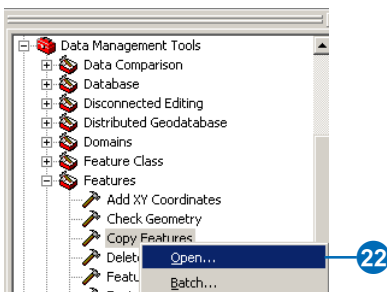

23. Click the Input Features drop-down arrow and click the `opt_areasM selection` selection layer.

24. Click the browse button next to the Output Feature Class parameter and navigate to `C:\Spatial\Stowe.gdb`, since this is the final result that you want to keep.

25. Type "final_site" for the name of the output feature class and click Save.

26. Click OK to run the tool.

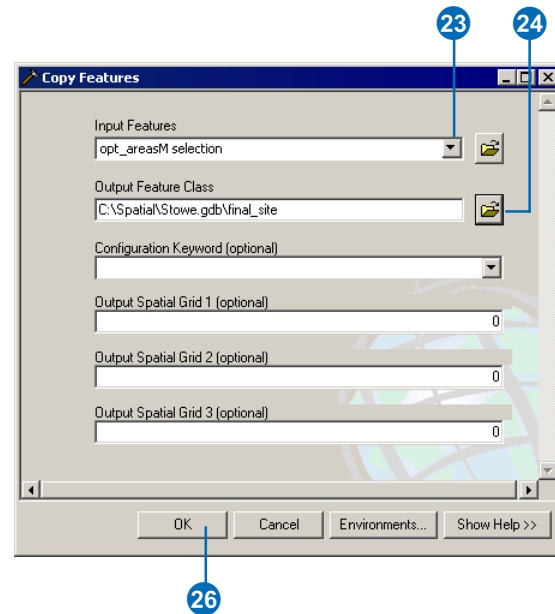

A feature class is created and added to the table of contents.

27. Click opt_areasM in the table of contents, press the Ctrl key, then click opt_areasM selection.

28. Right-click and click Remove.

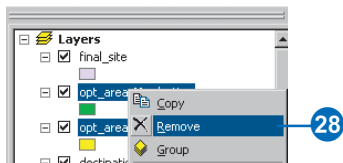

The final_site layer displays the location of the optimal site for the new school.

Optimal site
for the new
school

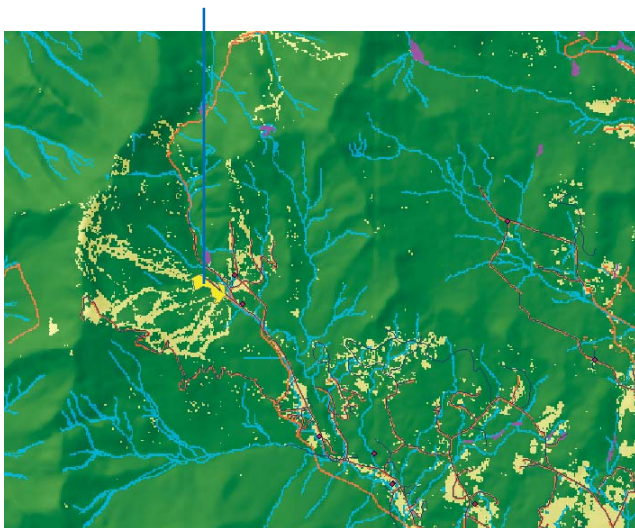

29. Click File on the Main Menu and click Save to save the map document.

You have now completed exercise 2. You can proceed to exercise 3, or you can stop and continue later.

Exercise 3: Finding an alternate access route to the new school site

In this exercise, you'll find the best route for a new access road. The steps you might follow to produce such a path are outlined below.

Create the source dataset if necessary. The source is the school site (the final_site feature class) you created in exercise 2.

Create the cost dataset by deciding which datasets are required, reclassifying them to a common measurement scale, weighting them, then combining them.

Perform cost distance analysis using the source and cost datasets as inputs. The distance dataset created from this tool is a raster in which the value of each cell is the accumulated cost of traveling from each cell back to the source.

To find the least costly path, you need a direction dataset, which can be created as an additional dataset using the Cost Distance tool. This gives you a raster of the direction of the least costly path from each cell back to the source (in this exercise, the school site).

Create the destination dataset if necessary. In this exercise, the destination dataset is a point at a road junction.

Perform cost path analysis using the distance and direction datasets created with the Cost Distance tool.

This exercise will take approximately 30 minutes to complete.

Setting up

If you are continuing from the previous exercise and have the Site Analysis map document open, go to the next section, 'Creating a new model'.

1. Start ArcMap by either double-clicking a shortcut installed on your desktop or using the Programs list on the Start menu.
2. Click C:\Spatial\Site Analysis.mxd in the Browse for maps list to open the map document created in the previous exercise or click Open on the Standard toolbar to navigate to the map document.

Creating a new model

You'll create a new model, Find Best Route, inside your Site Analysis Tools toolbox. This model will calculate the best path through the landscape from the source (the school site) to the destination point, taking into consideration the slope of the land and the type of land use the path will cross.

1. Right-click the Site Analysis Tools toolbox, point to New, and click Model.

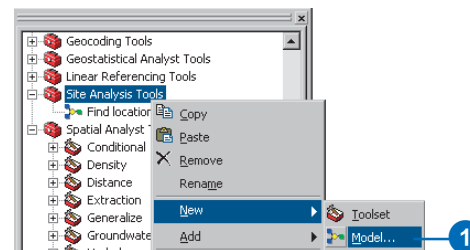

An empty ModelBuilder window will open.

2. Click the Model menu and click Model Properties.

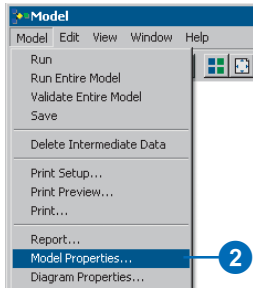

3. Click the General tab and type “find_route” in the Name text box.

4. Type “Find Best Route” in the Label text box.

The name is used in scripting and at the command line. The label is the display name for the model.

5. Check Store relative path names (instead of absolute paths) so that all paths for sources of information referenced by the tool are saved relative to the location of the toolbox. If the toolbox and its data are moved, paths to data sources will be altered accordingly.

6. Click the Environments tab and choose the same environment settings for this model as you did for the model created in exercise 2.

General Settings section: Check Current Workspace, Extent, and Scratch Workspace.

Raster Analysis Settings section: Check Cell Size.

7. Click Values.

8. Expand the General Settings section of the Environment Settings dialog box and set the following parameters:

Current Workspace = C:\Spatial

Extent = Same as Layer “elevation”

Scratch Workspace = C:\Spatial\Results

9. Expand Raster Analysis Settings and set the Cell Size parameter value to be the same as the elevation layer.

10. Click OK on the Environment Settings dialog box.

11. Click OK on the Model Properties dialog box.

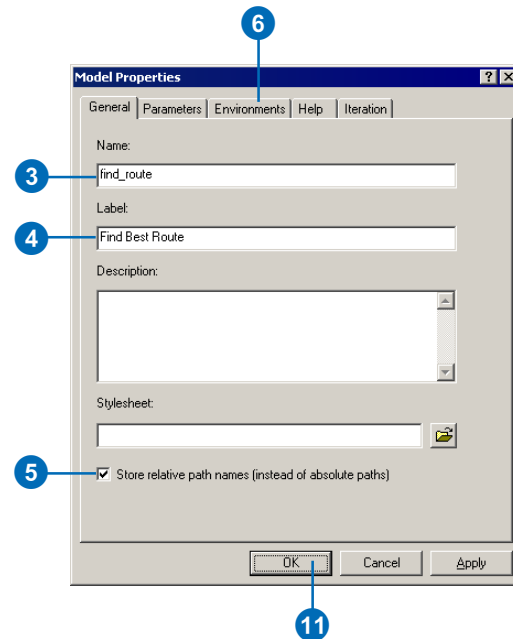

12. Click the Model menu and click Save.

Creating the cost dataset

You created the source dataset in the previous exercise. This is the location of the school site (your final_site layer). You'll create the cost dataset that will identify the cost of traveling over the landscape from any location back to the school, based on the fact that it is costlier to traverse steep slopes and construct a road on certain land-use types.

Deriving slope

It is difficult to build a road on steep slopes, so you'll calculate slope to take into consideration the slope of the land.

1. In the Spatial Analyst Tools toolbox, expand the Surface toolset.
2. Click and drag the Slope tool onto the ModelBuilder window.

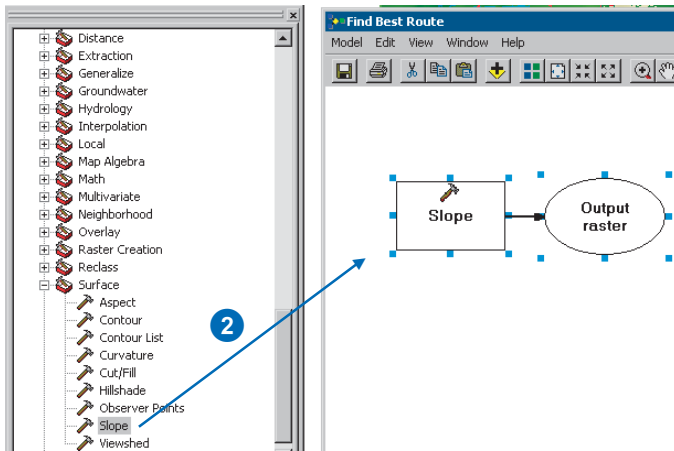

An element that references the Slope tool is created in the display window.

3. Right-click the Slope tool element and click Open.

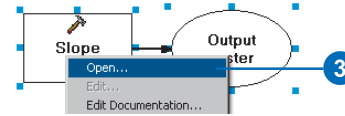

4. Click the Input raster drop-down arrow and click the elevation layer.
5. Accept the default path for the Output raster parameter value and type "Slope_ex3" for the name. The default path is set to the scratch workspace (for example, C:\Spatial\Results) you set earlier on the Environment Settings dialog box.
6. As you did when calculating slope in exercise 2, type "0.3048" for the value of the Z factor parameter to convert the z-values to the same unit of measure as the x,y units (from feet to meters).
7. Click OK.

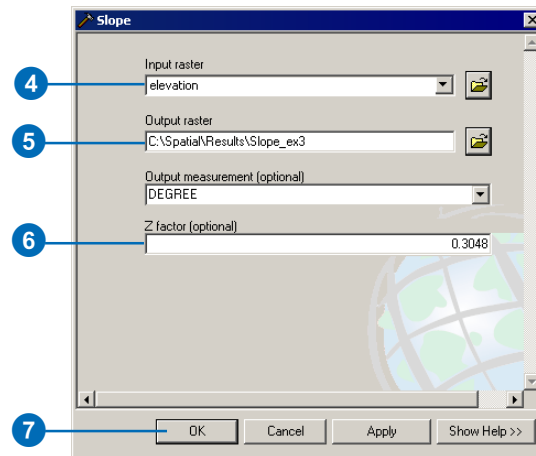

- Click the Auto Layout button, then click the Full Extent button to apply the current diagram properties to the elements and place them within the display window.

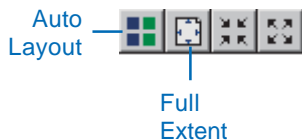

- Right-click the derived data element for the Slope tool and click Rename.
- Type "Slope output" and click OK.

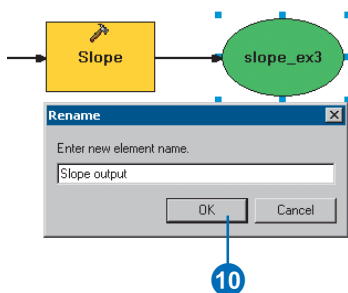

- Right-click the Slope output derived data element and click Add To Display.

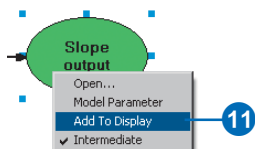

- Right-click the Slope tool element and click Run to run the process.

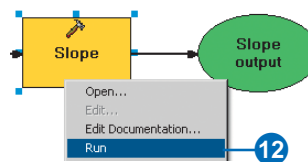

- Examine the layer added to your ArcMap display. Steep slopes are displayed in red and less steep slopes in green in the output layer.

Reclassifying slope

It is preferable that the new road traverses less steep slopes. You will reclassify the slope layer, slicing the values into equal intervals. You'll assign a value of 10 to the most costly slopes (those with the steepest angle of slope), 1 to the least costly slopes (those with the least angle of slope), and rank the values in between linearly.

1. In the Spatial Analyst Tools toolbox, expand the Reclass toolset.
2. Click and drag the Reclassify tool onto the ModelBuilder window.

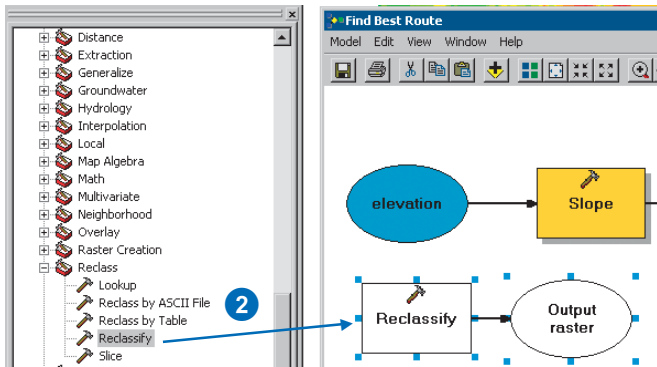

An element that references the Reclassify tool is created on the display window.

3. Right-click the Reclassify tool element and click Open.
4. Click the Input raster drop-down arrow and click the Slope output variable.
5. Accept the default for the Reclass field parameter so the Value field will be used.
6. Click Classify.

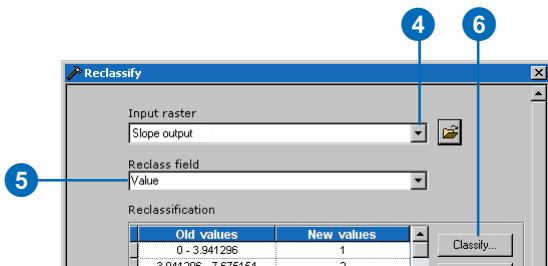

7. Click the Method drop-down arrow and click Equal Interval.
8. Click the Classes drop-down arrow and click 10.
9. Click OK.

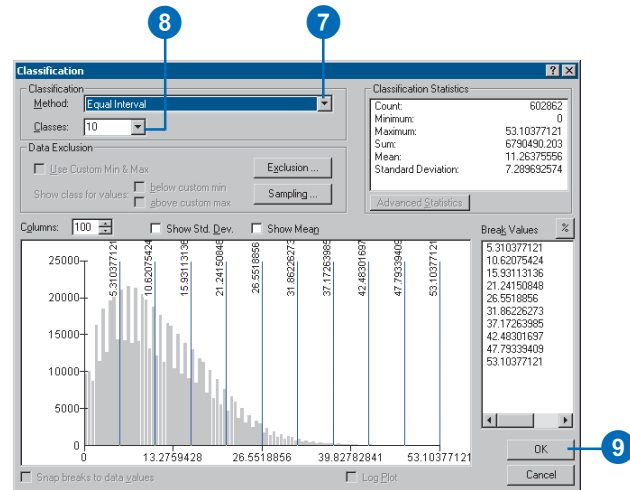

You want to avoid steep slopes when constructing the road, so steep slopes should be assigned higher values in the cost dataset. Because the default assigns higher values to steeper slopes, you do not need to change the default New Values.

10. Accept the default location for the value of the Output raster parameter, but type “Rslope_ex3” for the name.
11. Click OK.

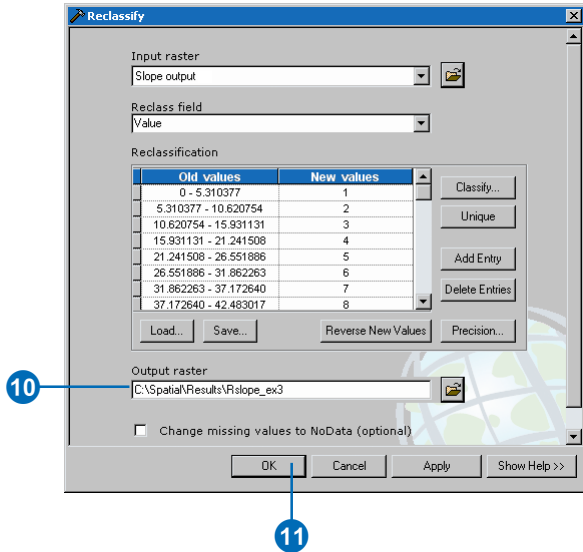

12. Click the Auto Layout button, then click the Full Extent button to apply the current diagram properties to the elements and place them within the display window.
13. Right-click the derived data element for the Reclassify tool and click Rename.
14. Type “Reclassified slope” and click OK.
15. Right-click the Reclassified slope derived data element and click Add To Display.

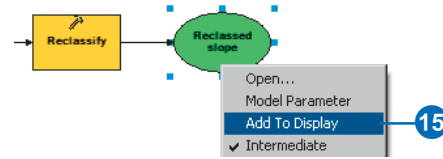

16. Right-click the Reclassify tool element and click Run to run the process.

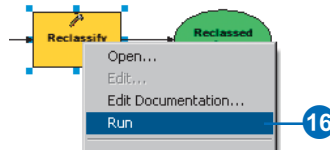

17. Examine the reclassified slope layer added to your ArcMap display. It shows locations that are costlier than others for constructing a road—higher values indicate the costlier areas that should be avoided.

Weighting and combining datasets

You will now combine the reclassified slope and landuse datasets to produce a dataset of the cost of building a road through each location in the landscape, in terms of steepness of slope and land-use type. In this model, each dataset has equal weight.

1. In the Spatial Analyst Tools toolbox, expand the Overlay toolset.
2. Click the Weighted Overlay tool and drag it onto the ModelBuilder window.

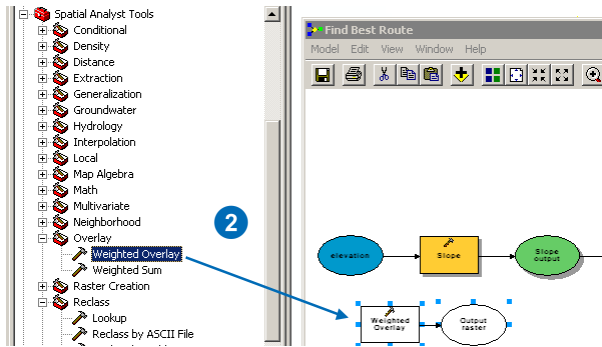

An element that references the Weighted Overlay tool is created in the display window.

3. Right-click the Weighted Overlay tool element and click Open.



The default evaluation scale is from 1 to 9 by 1. As in exercise 2, a scale of 1 to 10 was used when reclassifying the slope dataset, so before adding input rasters to the Weighted Overlay tool, you'll set the evaluation scale from 1 to 10 by 1. This means you will avoid having to update the scale values after adding your input slope dataset.

4. Type "1", "10", and "1" in the From, To, and By text boxes.

5. Click the Add Raster Row button to add the input rasters.

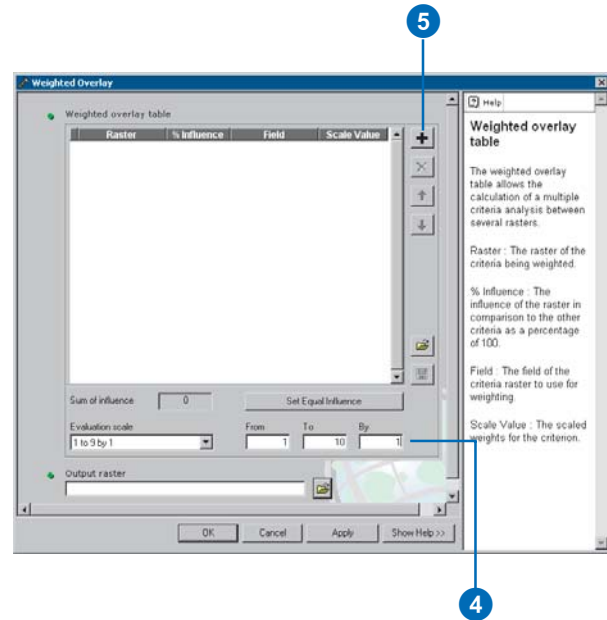

6. Click the Input raster drop-down arrow and click the Reclassified slope variable.
7. Accept the default value for the Input field parameter and click OK.

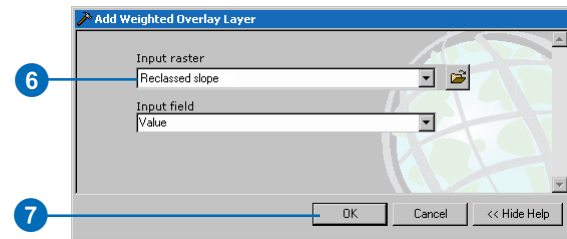

The raster is added to the Weighted Overlay dialog box. The Field column displays the values of the reclassified slope output. The Scale Value column mimics the Field column because the evaluation scale was set to encompass the range of values in each input raster. You'll keep the scale values as they are, since they have already been altered according to suitability.

Raster	% Influence	Field	Scale Value
Reclassified slope	100	Value	
		1	1
		2	2
		3	3
		4	4
		5	5
		6	6
		7	7
		8	8
		9	9
		10	10
		NODATA	NODATA

8. Click the Add Raster Row button again to add the landuse input raster.
9. Click the Input raster drop-down arrow and click the landuse layer.
10. Click the Input field drop-down arrow and click Landuse.
11. Click OK.

You'll weight the scale values of the landuse layer so they are comparable with your Reclassed slope derived dataset. A higher value indicates that it is costlier to build a road through a particular landuse type.

12. Type the following scale values:

Brush/transitional—5

Water—10

Barren land—2

Built up—9

Agriculture—4

Forest—8

Wetlands—10

Raster	% Influence	Field	Scale Value
		3	3
		4	4
		5	5
		6	6
		7	7
		8	8
		9	9
		10	10
		NODATA	NODATA
landuse	0	Landuse	
		Brush/transitional	5
		Water	10
		Barren land	2
		Built up	9
		Agriculture	4
		Forest	8
		Wetlands	10
		NODATA	NODATA

12

Note: Be cautious when using Restricted for the scale value when creating a cost surface. Using Restricted assigns a value to the cell that is the minimum value of the evaluation scale minus 1 (zero in this exercise), so your restricted areas will appear to be assigned the lowest cost when they are actually excluded from the analysis. Cells with this value should be rendered appropriately to avoid confusion. You could, instead, assign a high cost or set the scale value to NoData for areas you want to exclude from the analysis. If NoData is used, check first that there are no areas of NoData in your input rasters. If there are, it will be difficult to tell whether an area of NoData is there because it was excluded or there was no original information at that location for one of your inputs.

You'll now assign an equal percentage of influence to each raster, since they are both equally important in this analysis.

13. Click Set Equal Influence to assign an equal percentage of influence (50 percent each) for landuse and Reclassed slope.
14. Accept the default path for the value of the Output raster parameter, but type "cost_surf" for the name.
15. Click OK on the Weighted Overlay dialog box.

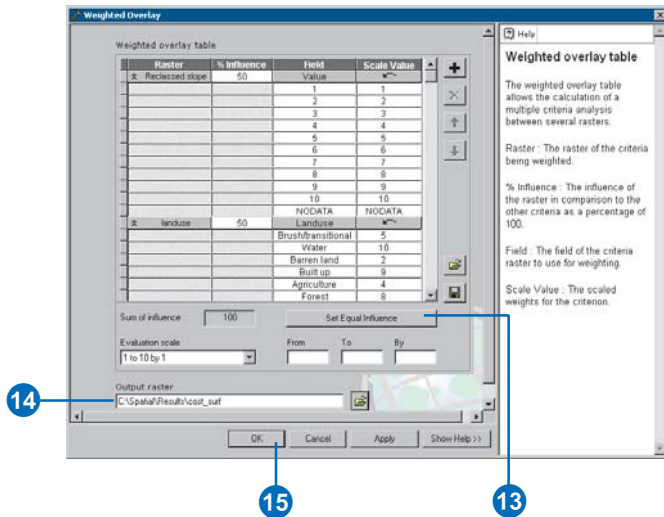

16. Click the Auto Layout button, then click the Full Extent button to apply the current diagram properties to the elements and place them within the display window.
17. Right-click the derived data element for the Weighted Overlay tool and click Rename.
18. Type "Cost surface" and click OK.

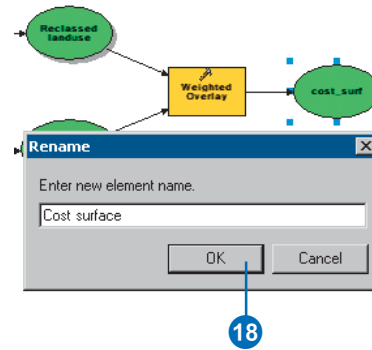

19. Right-click the Cost surface derived data element and click Add To Display.
20. Right-click the Weighted Overlay tool element and click Run to run the process.

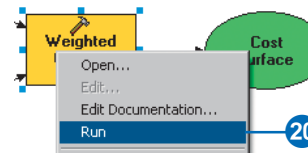

21. Examine the layer added to your ArcMap display. Locations with low values indicate areas that will be the least costly to build a road through.

Performing cost distance

You will now run the Cost Distance tool using the cost dataset you just created (which identifies the cost of traveling through each cell) and the final_site layer (the source) you created in exercise 2. The outputs from this tool are a distance dataset in which each cell contains a value representing the accumulated least cost of traveling from that cell to the source and a backlink dataset that gives the direction of the least costly path from each cell back to the source.

1. In the Spatial Analyst Tools toolbox, expand the Distance toolset.
2. Click and drag the Cost Distance tool onto the ModelBuilder window.

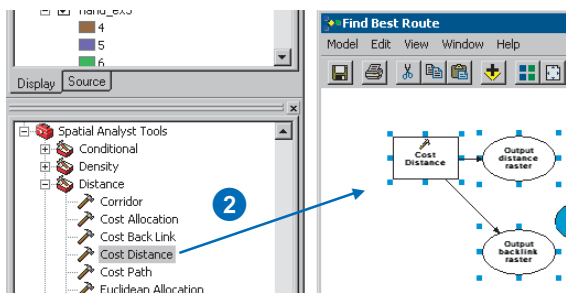

An element that references the Cost Distance tool is created in the display window.

3. Right-click the Cost Distance tool element and click Open.
4. Click the Input raster or feature source data drop-down arrow and click the final_site layer.

5. Click the Input cost raster drop-down arrow and click the Cost surface variable (the output from the Weighted Overlay tool).
6. Accept the default path for the Output distance raster, but change the name to “cost_dist”.
7. Type “C:\Spatial\Results” (or an alternative drive) for the path of the Output backlink raster parameter, and type “cost_bklink” for the name of the output.
8. Click OK.

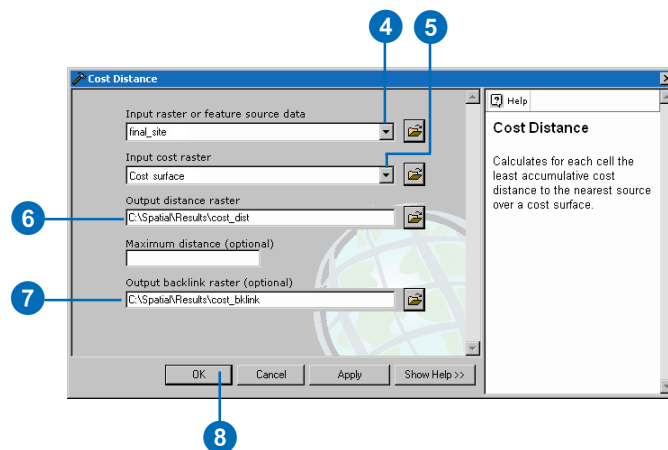

9. Click the Auto Layout button, then click the Full Extent button to apply the current diagram properties to the elements and place them within the display window.

- Right-click the `cost_dist` derived data element and click Rename.

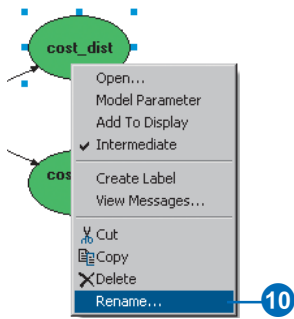

- Type “Output cost distance” and click OK.
- Right-click the Output cost distance derived data element and click Add To Display.
- Right-click the `cost_bklink` derived data element and click Rename.
- Type “Output cost backlink” and click OK.
- Right-click the Output cost backlink derived data element and click Add To Display.
With the Add To Display property checked, the derived data referenced by these elements will be added to the display each time the model is run.
- Right-click the Cost Distance tool element and click Run to run the process.

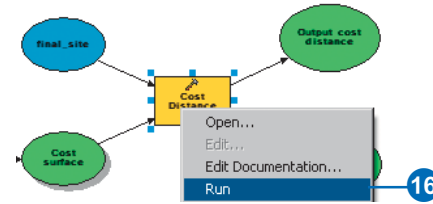

- Examine the layers added to your ArcMap display. The cost distance layer (`cost_dist`) displays the accumulated cost of traveling from any location (or cell) to the source (the school site). It does not contain information on which way to travel from a particular cell to the source, just how much it will cost to get there, following the least costly path. The cost backlink layer (`cost_bklink`) shows which way to travel from any cell, following the least costly path back to the source.

Finding the least costly path

The new road will redirect much of the traffic away from the existing road to the school and provide a back route for school buses and other vehicles.

- Examine the destination layer in the table of contents of your ArcMap session. This is the starting point for the new road to the school site.

- In the Spatial Analyst Tools toolbox, expand the Distance toolset.
- Click and drag the Cost Path tool onto the ModelBuilder window.

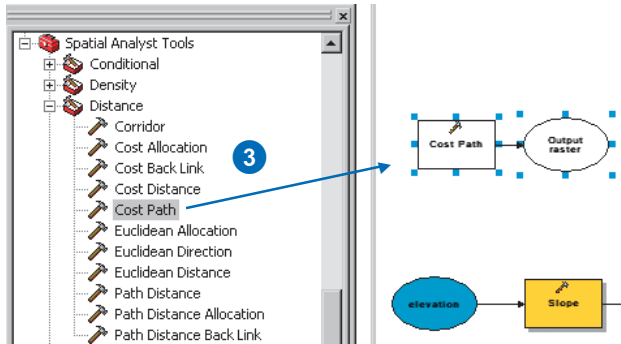

An element that references the Cost Path tool is created in the display window.

- Right-click the Cost Path tool element and click Open.
- Click the Input raster or feature destination data drop-down arrow and click the destination layer.
- Click the Input cost distance raster drop-down arrow and click the Output cost distance variable (one of the outputs from the Cost Distance tool).
- Click the Input cost backlink raster drop-down arrow and click the Output Cost Backlink variable (one of the outputs from the Cost Distance tool).
- Accept the default path for the Output raster parameter, but change the name to “cost_path”.

When the input feature destination data is processed, it will be converted temporarily to a grid as part of the processing. There will only be one cell in this grid,

because there is only one destination point. The value for the Path type parameter can be left as EACH_CELL. Only one path will be created, since there is only one cell.

- Click OK.

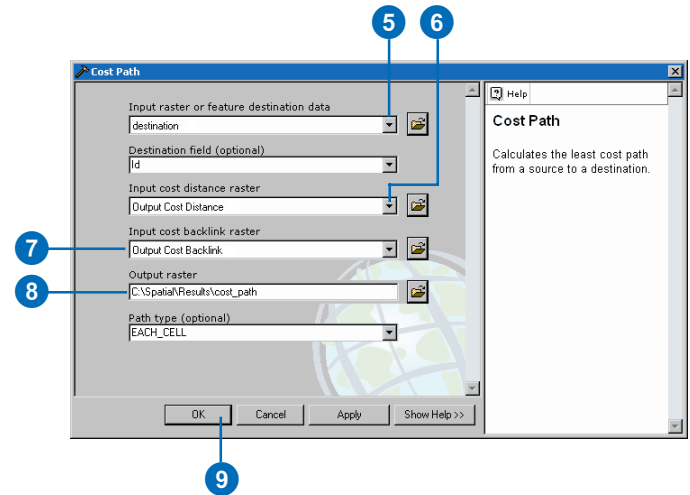

- Click the Auto Layout button, then click the Full Extent button to apply the current diagram properties to the elements and place them within the display window.

- Right-click the cost_path derived data element and click Rename.

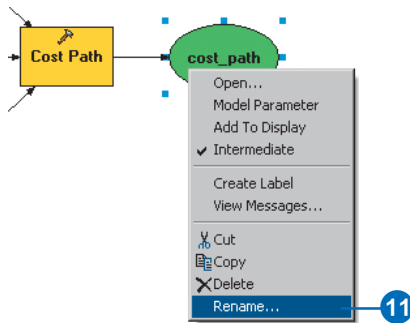

- Type “Output cost path” and click OK.
- Right-click the Output cost path derived data element and click Add To Display.
- Right-click the Cost Path tool element and click Run to run the process.

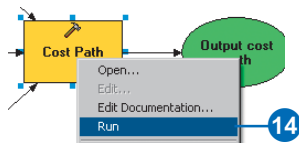

- Remove the created layers Slope output, Reclassed slope, Cost surface, Output cost distance and Output cost backlink so you can see the path displayed over the landuse and hillshd layers.

- Examine the layer added to your ArcMap display. The Output cost path layer represents the least costly path from the school site to the destination point. It avoids steep slopes and certain land-use types that are considered costlier for constructing the road.

As a last step in your model, you’ll convert the raster path to a polyline for display.

- In the Conversion Tools toolbox, expand the From Raster toolset.
- Click and drag the Raster to Polyline tool onto the ModelBuilder window.

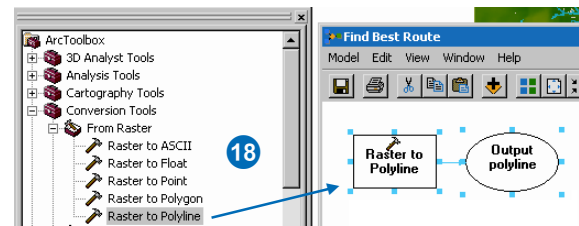

An element that references the Raster to Polyline tool is created in the display window.

- Right-click the Raster to Polyline tool element and click Open.

20. Click the Input raster drop-down arrow and click the Output cost path variable.
21. Leave the default Field as VALUE.
22. Click the browse button next to the Output polyline features parameter and navigate to your file geodatabase C:\Spatial\Stowe.gdb.
23. Type “new_route” for the name of the feature class and click Save.
24. Accept the defaults for all other parameters and click OK.

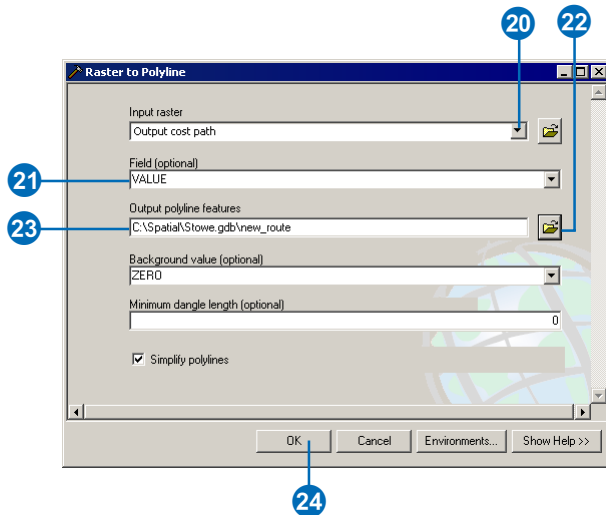

25. Click the Auto Layout button, then click the Full Extent button to apply the current diagram properties to the elements and place them within the display window.
26. Right-click the new_route derived data element and click Rename.

27. Type “Output route” and click OK.
28. Right-click the Output route derived data element and click Add To Display.
29. Right-click the Raster to Polyline tool element and click Run to run the process.

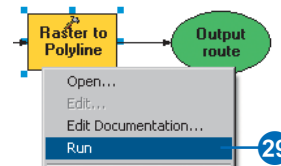

30. Examine the new_route layer that is added to your ArcMap display. The raster path has been converted to a polyline.

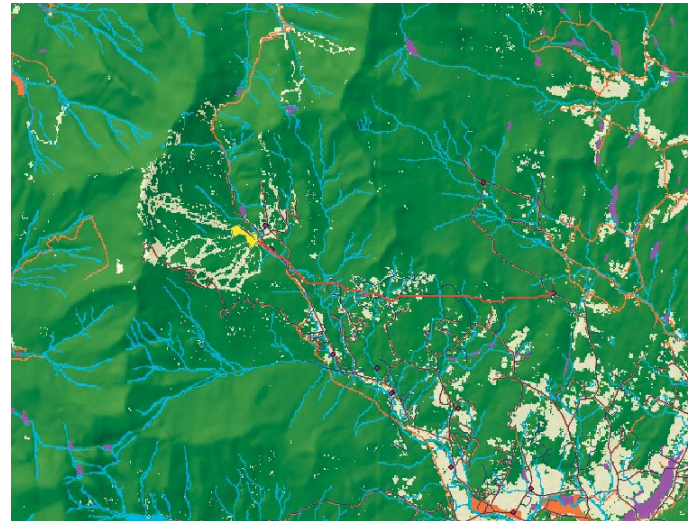

Note: You can easily change parameter values to experiment with different outcomes and rerun the model. Only the processes in the model that are dependent on the output of the altered process will need to be rerun. For example, lowering the weight applied to cell values where the landuse is built up from 9 to 1 will alter the potential path for the new road considerably—it will tend to follow existing roads where it can, which may be a less costly option to consider.

Setting model parameters

As you did with the Find location for school model, you'll rename some of the variables and set them as model parameters so they will display on the model's dialog box.

1. Right-click the landuse project data element and click Rename.

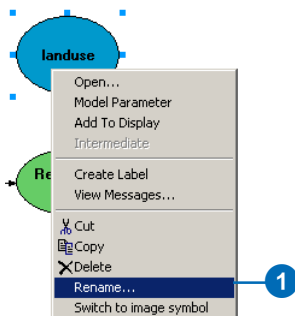

2. Type “Input landuse raster” and click OK.
3. Right-click the elevation project data element and click Rename.
4. Type “Input elevation raster” and click OK.
5. Right-click the final_site project data element and click Rename.

6. Type “Input source” and click OK.
7. Right-click the destination project data element and click Rename.
8. Type “Input destination” and click OK.
9. Right-click Input landuse raster, Input elevation raster, Input source, Input destination, and Output route, then click Model Parameter.

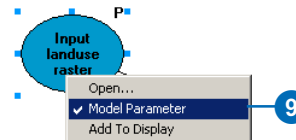

10. Click the Model menu and click Save.

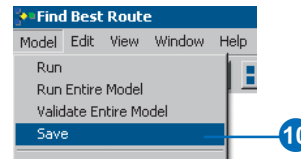

11. Click the Model menu again, and click Close.

Viewing the model's dialog box

1. Right-click the Find Best Route model in the ArcToolbox window and click Open, or double-click the tool.

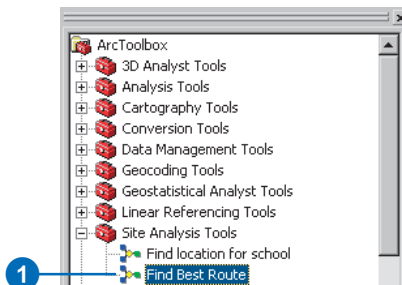

The variables you made into model parameters are displayed as the parameters on the model's dialog box. Users of your model can enter their own parameter values to find suitable routes from point A to point B in their area without having to know much information about the underlying workings of the model. As with the Find location for the school model, they would, of course, need to have the same fields present in the landuse data, understand the methodology of the model, and agree with the assumptions applied.

2. Click Cancel on the model's dialog box.

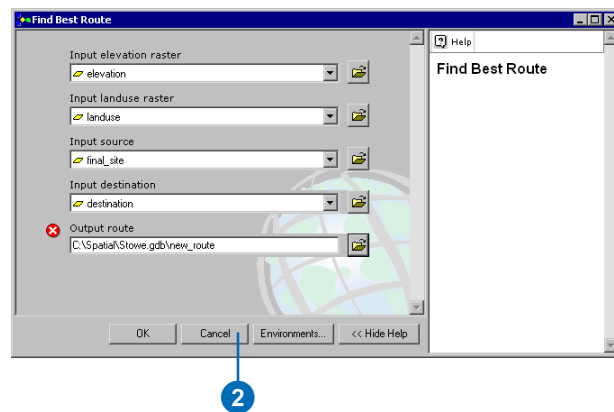

Saving the map document

You have set relative paths for both models created in this tutorial, so if the toolbox containing the models and the data are moved (keeping the same structure between them) to a new location on disk, the paths to the data sources will be set relative to the position of the toolbox. You should also set relative paths for your map document so layers in the table of contents will find their data sources by traversing the relative paths.

1. Click File and click Document Properties.

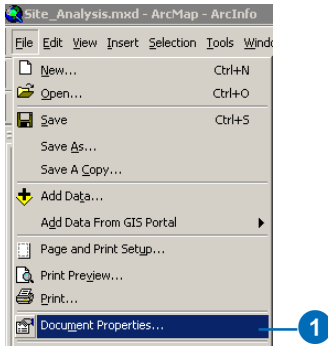

2. Click Data Source Options.
3. Check Store relative path names to data sources and click OK.
4. Click OK on the Site_Analysis.mxd Properties dialog box.

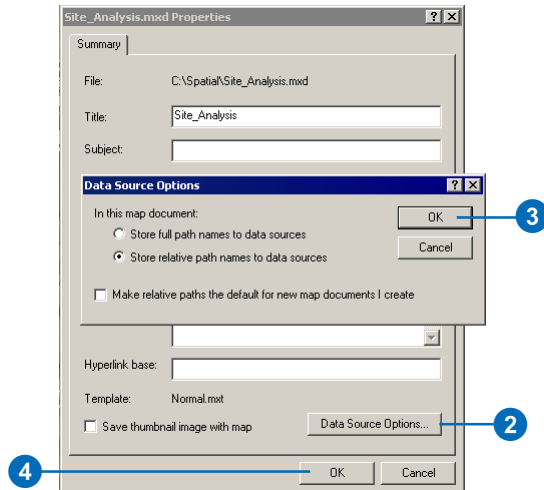

5. Click File and click Save.
6. Click File and click Exit.

This brings you to the end of this tutorial. You have been introduced to some of the tools available with Spatial Analyst, both through the Spatial Analyst toolbar and the Spatial Analyst Tools toolbox. You've learned how to build models that are reusable and can be shared with others. In particular, you've learned how to create a suitability map, and you've learned how to calculate the least costly path across a landscape. The sequences of steps involved can be applied to many different applications.

There are many more tools you can use to help you perform your spatial analysis tasks. The Spatial Analyst Help in the ArcGIS Desktop Help system will guide you as you learn how to solve your own specific spatial problems. It contains conceptual help for each toolset and help for each tool in the Spatial Analyst Tools toolbox. The ArcGIS Desktop Help system can also be explored for more information on the geoprocessing functionality within ArcGIS.